

.elmar

**KITCHEN
PHILOSOPHY**

KITCHEN PHILOSOPHY_

- p. 4 **We design innovation_**
PROGETTIAMO INNOVAZIONE
- p. 6 **We take care of details and customize solutions_**
CI PRENDIAMO CURA DEI DETTAGLI E DELLE
SOLUZIONI PERSONALIZZATE
- P. 8 **We create family atmospheres_**
CREIAMO ATMOSFERE FAMILIARI
- p. 10 **Atmospheres_**
ATMOSFERE
- p. 166 **Materials_**
MATERIALI

We design innovation_ PROGETTIAMO INNOVAZIONE

Nato nel 1978, Elmar è oggi un brand italiano dinamico, la cui identità è riconosciuta a livello internazionale. Per Elmar il cambiamento è progresso e il progresso è miglioramento della qualità della vita.

La nostra passione è progettare, realizzare e commercializzare soluzioni d'eccellenza per gli ambienti cucina e bagno. In un mondo in continua evoluzione in termini di materiali, know-how e ricerca della qualità e del bello, abbiamo sempre risposto accettando sfide quotidiane e proponendo soluzioni innovative e di pregio, rivolte ai giovani così come alle persone di esperienza. Per anni abbiamo innovato lavorando sulle potenzialità dello "spazio cucina" e abbiamo progettato sistemi in movimento nella convinzione che la cucina debba essere un ambiente flessibile, da vivere nelle varie fasi della giornata: con i nostri tavoli a scomparsa o con le nostre colonne attrezzate moltiplichiamo lo spazio disponibile per la preparazione e l'ospitalità. Le lunghe cooperazioni con architetti e designers hanno generato idee, linee e prodotti capaci di dialogare con qualsiasi soluzione architettonica e di spazio. In particolare, negli ultimi anni, con lo studio C+S Architects abbiamo spostato l'attenzione dall'oggetto cucina ad un sistema di relazioni con lo spazio, progettando e realizzando programmi capaci di reinventare la casa attraverso una serie di nuove connessioni tra gli ambienti.

.e

Founded in 1978, today Elmar is a dynamic Italian brand recognised the world over. For Elmar, change means progress and progress means improving quality of life.

Our passion is for planning, making and selling excellent solutions for kitchens and bathrooms. In a world which is continuously evolving in terms of materials, know-how and research into quality and aesthetics, we have always replied to the challenge of day-to-day life offering innovative and sought-after solutions, designed for the young as well as the more experienced. For years now, we have innovated by working on the potential of the "kitchen space", and we have designed moving systems, convinced that the kitchen should be a flexible environment, to be lived in at various times of the day: with our hide-away tables or with our fitted columns we multiply the space available for preparing or hosting. Long-standing collaboration with architects and designers has generated ideas, ranges and products that can match any architectural solution or space. Over the last few years in particular, in partnership with C+S Architects, we have married the attention to the kitchen object to a space-relation system - designing and making programmes able to re-invent the home through a series of new connections between spaces.



We take care of details and customize solutions_

CI PRENDIAMO CURA DEI DETTAGLI E DELLE SOLUZIONI PERSONALIZZATE

Offriamo un'ampia e ricercata gamma di materiali che spazia dai laminati effetto seta all'argilla, dalle laccature opache a quelle lucide, dalle finiture metalliche ai legni pregiati e al gres.

Tutte le nostre proposte sono personalizzabili e intendono superare la contrapposizione tra industria e produzione artigianale. Infatti i vari componenti, anche se prodotti industrialmente, sono personalizzabili nelle dimensioni e nelle finiture e restituiscono la memoria di un'atmosfera accogliente in cui il dettaglio è curato come se fosse stato fatto a mano. L'expertise quarantennale di Elmar nella realizzazione delle cucine coniuga design e funzionalità del prodotto con la maestria artigianale italiana.

Prodotti che durano, studiati per soddisfare ogni tipo di esigenza.

.e

We offer a wide and sought-after range of materials, from laminates with effects from silk to clay, opaque and matt varnishes, metallic and precious wood finish as well as stoneware.

Our entire offering is customisable and are designed to go beyond the overlap between industrial and artisan production. Indeed, the various components, even if industrially produced, can be customised in terms of size and finish and evoke the memories of a welcoming atmosphere in which the attention to detail is comparable to a hand made piece. Elmar's over 40 years' experience in making kitchens marries design and functionality of the product with masterful Italian hand crafts.

Products that last, designed to satisfy any requirement.

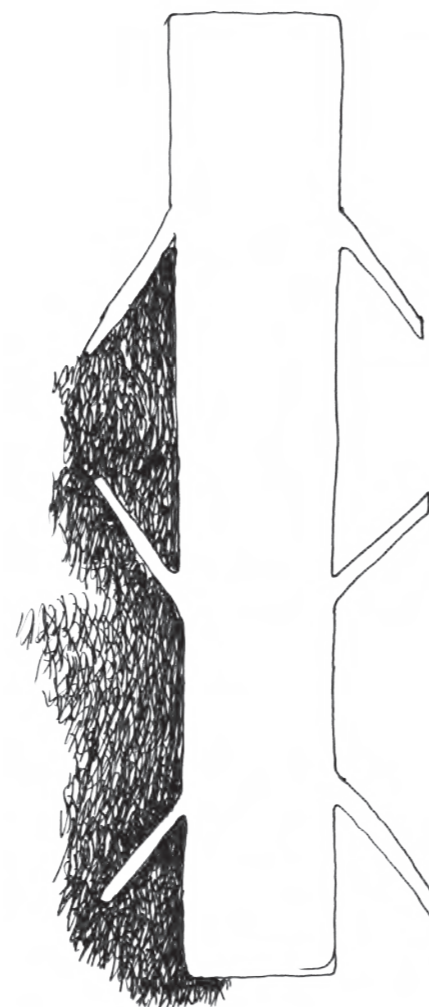

We create family atmospheres_

CREIAMO ATMOSFERE FAMILIARI

Desideriamo trasformare la cucina da macchina funzionale in spazio da abitare, costruendo l'atmosfera e le relazioni tra lo spazio e i suoi abitanti, per farli stare bene, a casa.

Così come la famiglia è un insieme affascinante, complesso e in costante divenire, la cucina deve interpretare ed esprimere le abitudini, le tradizioni e le aspirazioni legate alla storia e alla cultura personali ed essere un'abile trasformista, deve saper accogliere dalla situazione più intima alla più formale. Per questo motivo non consideriamo la cucina come un sistema predefinito (dato) di elementi ma come una serie di soggetti che fluttuano nella memoria e attendono di essere interpretati: un grande tavolo o un'isola per stare bene insieme a gustare, parlare, preparare, guardarsi; un fuoco attorno a cui sedersi e lavorare, una libreria dove collezionare libri e oggetti preziosi, una credenza elegante e flessibile, una cappa che trasforma il cibo in musica.

.e

We want to transform the kitchen from a functional machine into a living space, by creating an atmosphere and a relationship between the space and its inhabitants, making them feel well, at home.

Just as family is a fascinating togetherness, complex and constantly evolving, the kitchen must interpret and express habits, traditions and ambitions linked to personal history and culture and be able to transform, welcoming every situation from the intimate to the formal. For this reason, we don't consider the system as a pre-defined system (given) of elements but as a series of items that float in the memory, waiting to be interpreted: a large table or an island to be together and eat, talk, prepare, look at each other; a fire to sit around and work, a bookcase to collect books and precious objects, an elegant and flexible cupboard, an extractor hood that transforms food into music.





The double height
EASY 30
p. 14

The classical
@HOME CUBE
p. 32

The minimal
EASY
p. 52

The loft
@HOME
p. 74

The open air
SLIM
p. 94

The lounge
EL_01
p. 112

The playfull
PLAYGROUND
p. 130

The traditional
REGULA
p. 148

Atmospheres_ ATMOSFERE

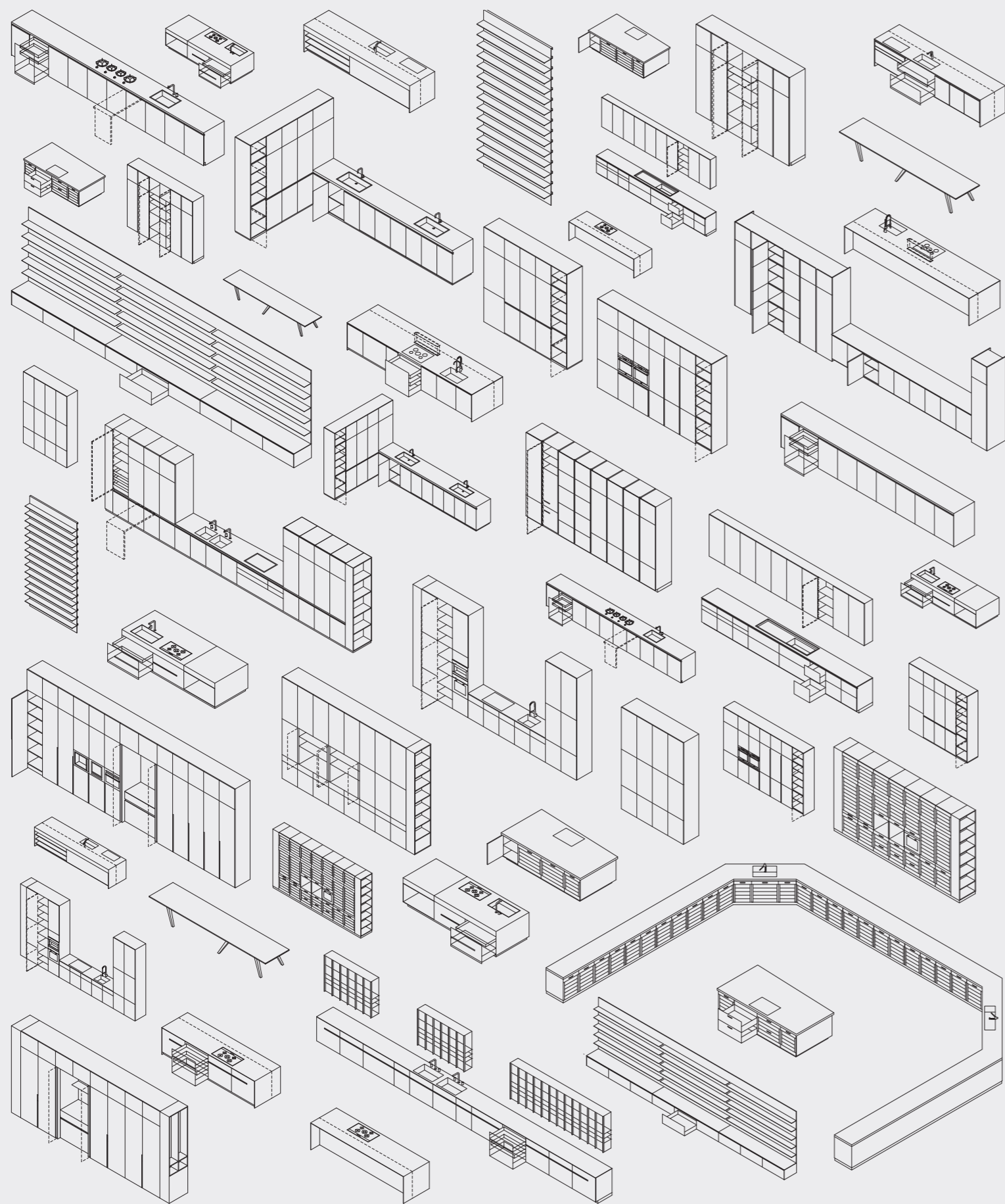

.elmar Kitchen Philosophy

“Chi ha detto che quello che è piacevole non può anche essere funzionale?”
Charles Eames.

Kitchen Philosophy è un sistema di potenzialità per creare atmosfere. Intercetta le memorie della cucina: uno spazio ricco di materie, gusto e profumi, di calore della casa e della famiglia, uno spazio informale dove lavorare e condividere il cibo e la conversazione, in cui ognuno di noi si sente ‘a casa’.

Sospesa tra tradizione e innovazione, Kitchen Philosophy è una selezione di suggestioni piuttosto che un catalogo di sistemi chiusi: prende forma nelle memorie della cucina, utilizzando le tecniche più sofisticate che il mercato della produzione mette a disposizione e spingendo il progetto oltre le mura della cucina per estenderlo a tutta la casa.

Kitchen Philosophy supera l’idea della cucina o del bagno come macchine superfunzionali e specializzate per proporre **atmosfera da abitare**.

Frammentando le componenti principali del sistema, la cucina si trasforma magicamente in spazio dove le **armadiature** diventano muri abitati che emanano bellezza nella preziosità delle finiture esterne, ma che mostrano altre potenzialità di funzionalità e materialità quando si aprono, rivelando pensili, fuochi, scaffalature, cotture e zone lavaggio, che sono di volta in volta customizzabili per adattarsi ai desideri degli abitanti.

Le **isole** diventano un grande **tavolo** da lavoro, un fuoco attorno al quale conversare, sedersi, lavorare. Lo spazio è disegnato da **librerie** dove raccogliere gli oggetti preziosi o il profumo delle spezie. Le **cappe** possono essere invisibili e alloggiare nei piani o diventare un organo, una vibrazione luminosa e sonora, che si materializza nella sequenza dei cilindri di dimensioni diverse, che contengono l’aspirazione insieme alle casse acustiche. Kitchen Philosophy istiga *“La relazione tra l’oggetto e il suo utilizzatore come una relazione di intense interazioni”* (Arnheim), in attesa di potersi modellare ai desideri degli abitanti.

Kitchen Philosophy si ricompone nei vari elementi non più come sistema dato, ma come possibile intonazione di un coro di voci che ciascuno dei materiali canta secondo l’intonazione di ogni abitante che diventa protagonista della propria atmosfera in casa e inizia a giocare trasformando le potenzialità in spazio.

.elmar Kitchen Philosophy

“Who said that what is attractive cannot also be functional?”
Charles Eames.

Kitchen Philosophy is a system of potential choices to create atmospheres. It captures the memories of the kitchen: a space filled with materials, taste and fragrances, the warmth of the home and the family, an informal space in which to work and share food and conversation, in which each of us feels ‘at home’.

Suspended between tradition and innovation, Kitchen Philosophy is a selection of proposals rather than a catalogue of closed systems: it takes shape in the memories of the kitchen, using the most sophisticated techniques that the production market has to offer, pushing design beyond the walls of the kitchen to extend it to the entire house.

Kitchen Philosophy surpasses the idea of the kitchen or bathroom as super-functional and specialised machines to offer instead **atmospheres to be lived in**.

By fragmenting the main components of the system, the kitchen magically transforms itself into a space where the **cupboards** become inhabited walls that exude beauty in the preciousness of the exterior finishes but which show other potential functionalities and materiality upon opening, revealing shelves, rings, units, hobs and washing areas, which are customisable on an individual basis to suit the tastes of the inhabitants.

The **islands** become a large work **surface**, a focus around which to converse, sit and work. The space was designed like a **bookshelf** in which to collect valuable objects or the fragrance of spices. The **hoods** can be invisible, accommodated in the hobs, or become an element, a luminous and audible vibration, that materialises in the sequence of cylinders of different sizes, which contain the extracting function together with the sound-enclosing units.

Kitchen Philosophy instigates *“The relationship between the object and its user as a relationship of intense interactions”* (Arnheim), waiting to be modelled on the wishes of the inhabitants.

Kitchen Philosophy is recomposed in the various elements no longer as a given system but as possible intonation of a choir of voices that each of the materials sings according to the intonation of each inhabitant who becomes the protagonist of their home atmosphere and begins to play, transforming the potential options into space.

The double Height_

EASY 30

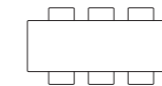
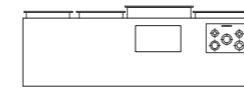
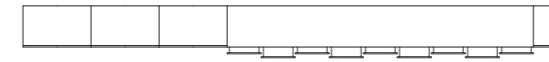

BASI / TOP_
BASE UNITS / TOP



Cemento grigio chiaro
Light grey concrete



Marmo Grey Saint Lauren
Marble Grey Saint Lauren

ISOLA_
ISLAND



Cemento grigio chiaro
Light grey concrete



Marmo Grey Saint Lauren
Marble Grey Saint Lauren



Acciaio
Stainless steel

COLONNE_
TALL UNITS



Cemento grigio chiaro
Light grey concrete

LIBRERIA_
SHELVING



Alluminio
Aluminium



Laccato bianco opaco
White matt laquered













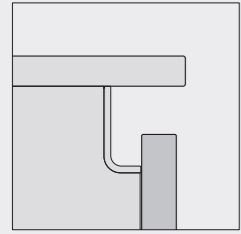

Easy
EASY

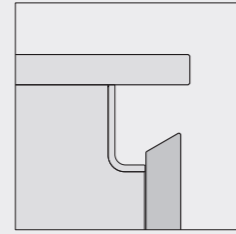

Easy 30
EASY 30

Wall units_ ELEMENTI A MURO

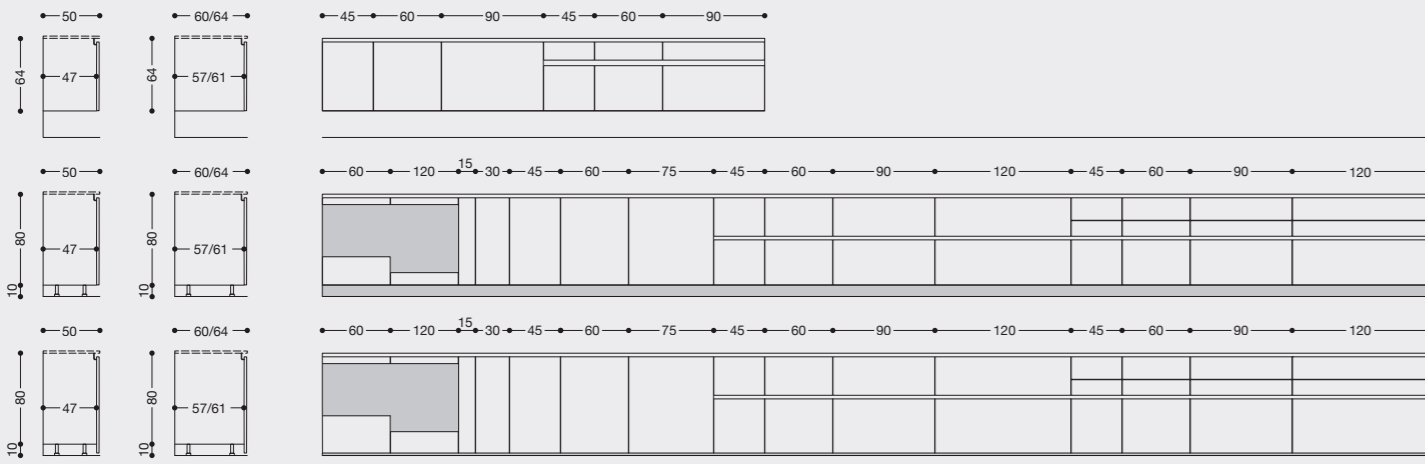

High_ ALTEZZA

64 cm

90,2 cm

90,2 cm

Wall units_ ELEMENTI A MURO



High_ ALTEZZA

46 cm

60 cm

80,2 cm

106,2 cm

140,2 cm

Alignements wall units and tall units_ ALLINEAMENTO UNITÀ A MURO E COLONNE

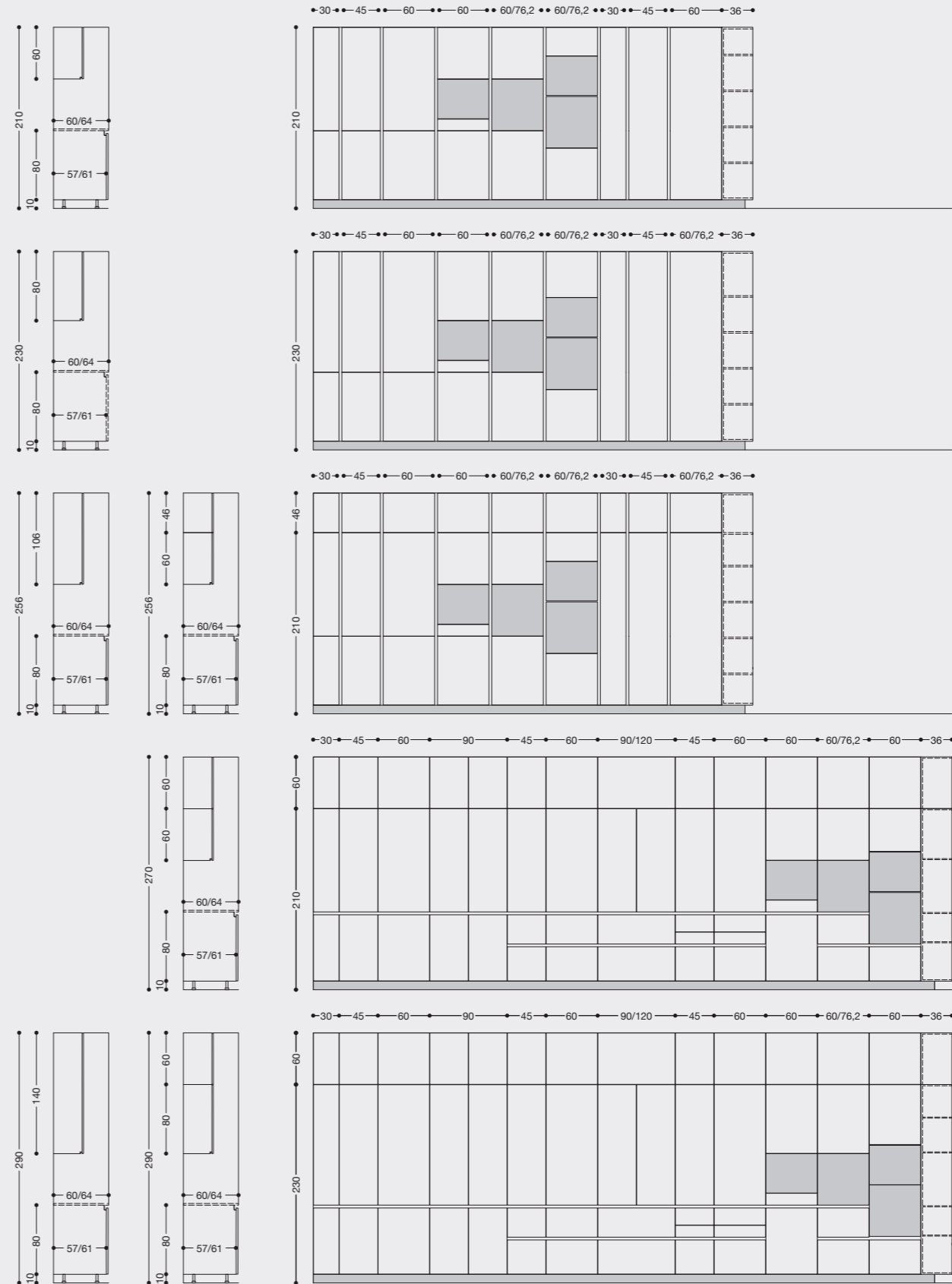

High_ ALTEZZA

210 cm

230 cm

256 cm

270 cm

290 cm



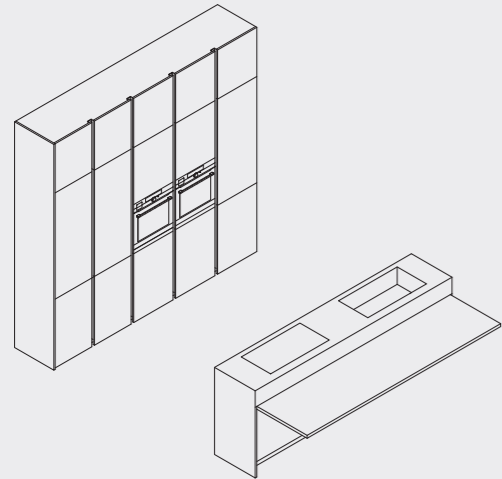

Island with wing table_
ISOLA CON WING TABLE

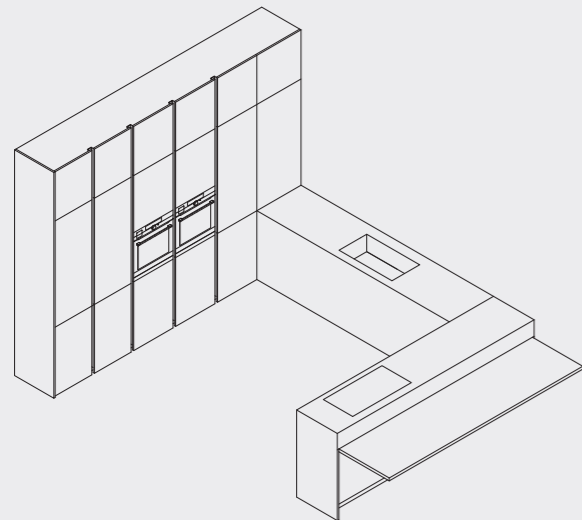

Peninsula with wing table_
PENISOLA CON WING TABLE

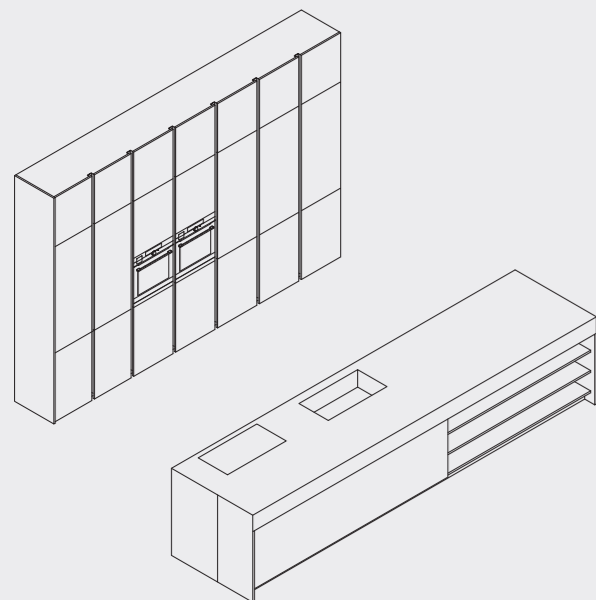

Wing table combined with a boiserie_
WING TABLE ABBINATO AD UNA
BOISERIE

Wing Table_

WING TABLE

Wing table appartiene alla famiglia delle soluzioni esclusive Elmar.

A sorpresa il pannello sul retro dell'isola o della penisola può ruotare dal basso verso l'alto e trasformarsi in Wing table, un tavolo profondo 64 cm che risolve all'occorrenza le funzioni di preparazione e accoglienza.

Aperto appare come un piano di soli 3 cm di spessore e lascia a vista lo schienale in acciaio dell'isola mentre chiuso il suo spessore scompare

all'interno della profondità del fianco dell'isola.

Wing table può essere lungo 120, 150, 180, 210, 240 cm in Unicolor, acciaio o in legno pregiato.

The Wing Table belongs to the exclusive Elmar solutions family.

The panel on the back of the island or peninsular can rotate from underneath

to the top and transform into a Wing Table, a table 64 cm deep that can solve any issue of space when preparing or entertaining in a flash.

When open, the surface is only 3cm thick and leaves the steel back of the island on show, whereas when closed the thickness is hidden inside the depth of the side of the island.

Wing Table can be 120, 150, 180, 210, or 240 cm long in Unicolor, steel or precious wood.

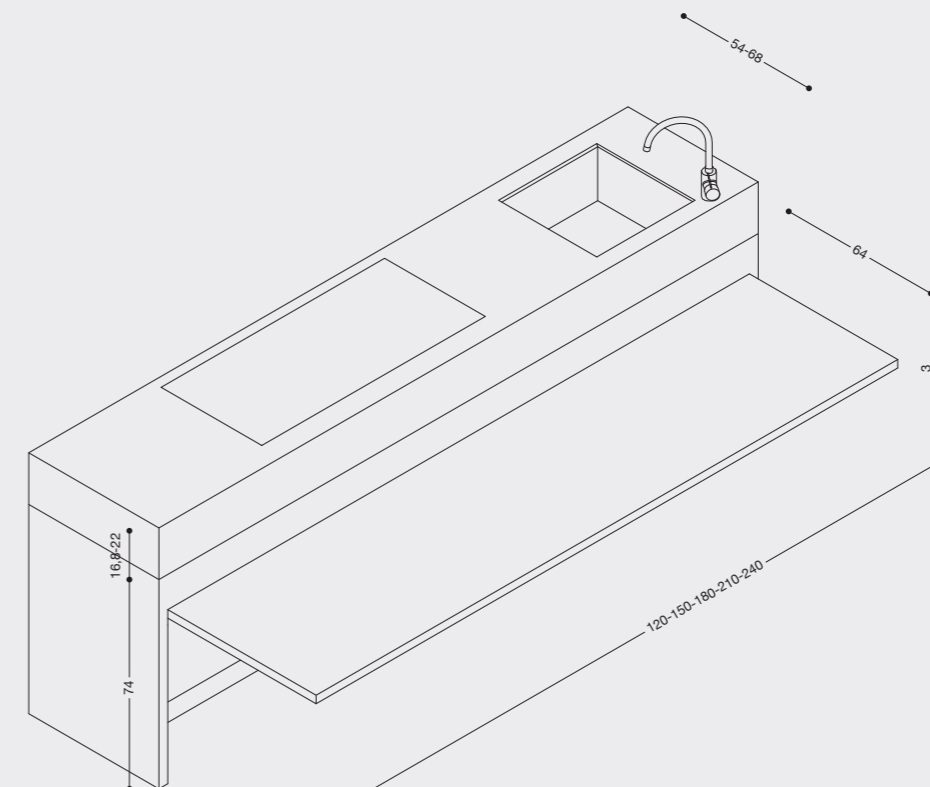

The Classical_

@HOME CUBE

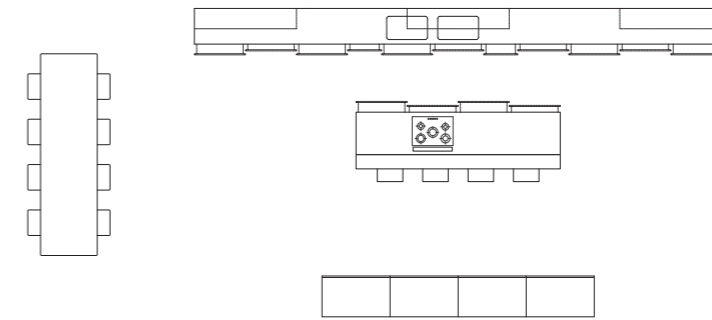

BASI / TOP_
BASE UNITS / TOP



Argilla ARA 32
Clay Ara 32



Gres Avorio
Gres Ivory

COLONNE_
TALL UNITS



Argilla ARA 32
Clay Ara 32



Laccato opaco a campione
Custom matt laquered

LIBRERIA_
SHELVING



Acciaio
Stainless steel



Noce Canaletto
Canaletto Walnut













.elmar

@homecube Details

45

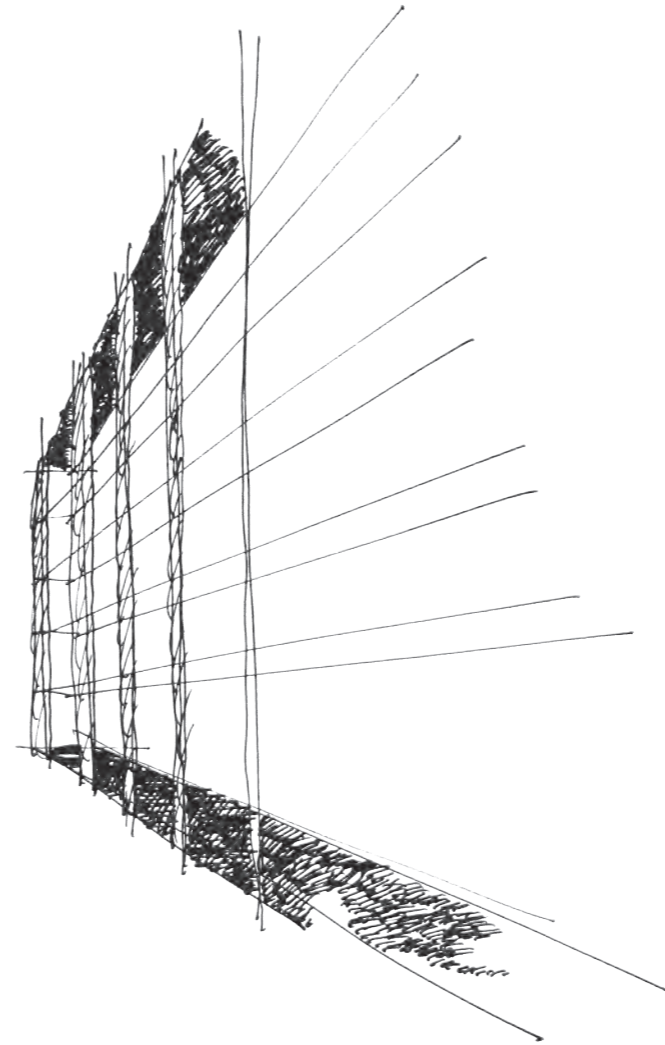



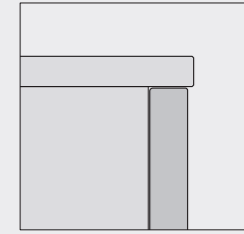

@Home cube_
@HOME CUBE

Wall units_
ELEMENTI A MURO

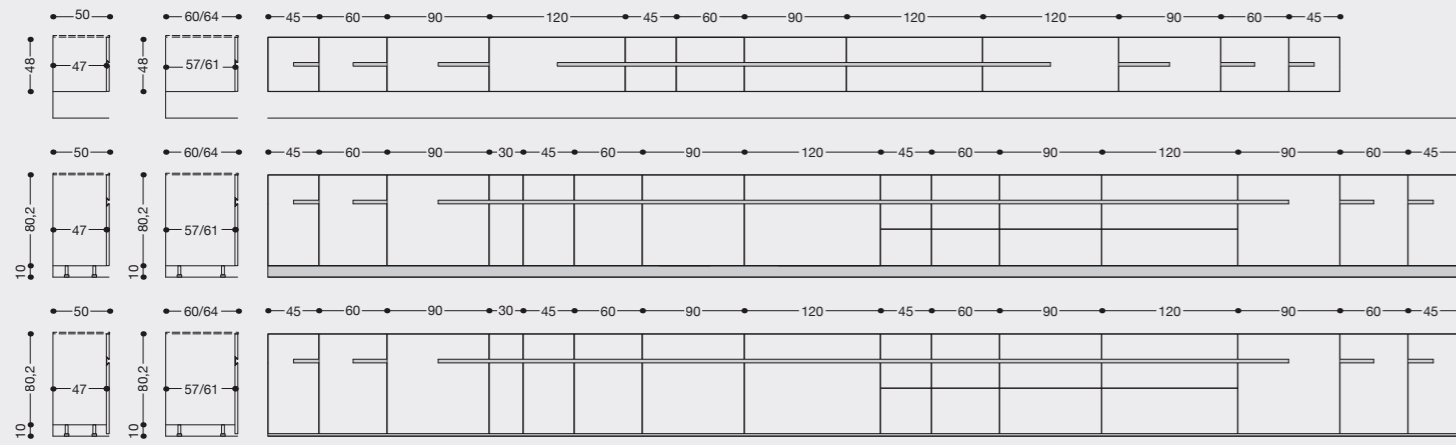

Wall units_
ELEMENTI A MURO

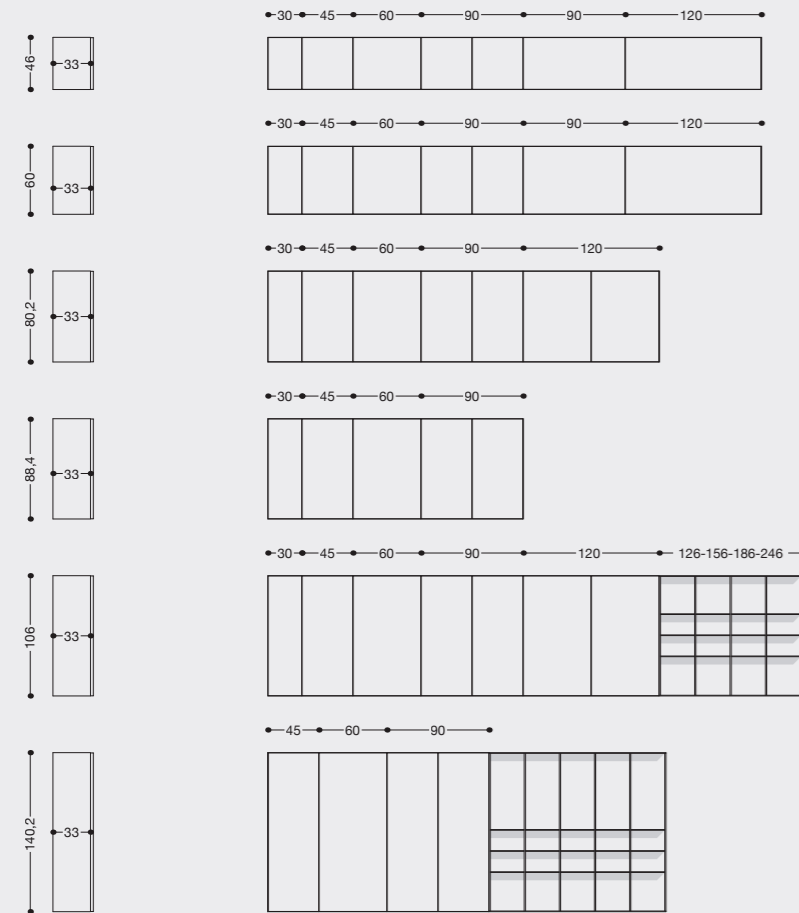

High_
ALTEZZA

48 cm

90,2 cm

90,2 cm

High_
ALTEZZA

46 cm

60 cm

80,2 cm

88,4 cm

106,2 cm

140,2 cm

Allineamenti wall units and tall units_
ALLINEAMENTO UNITÀ A MURO E COLONNE

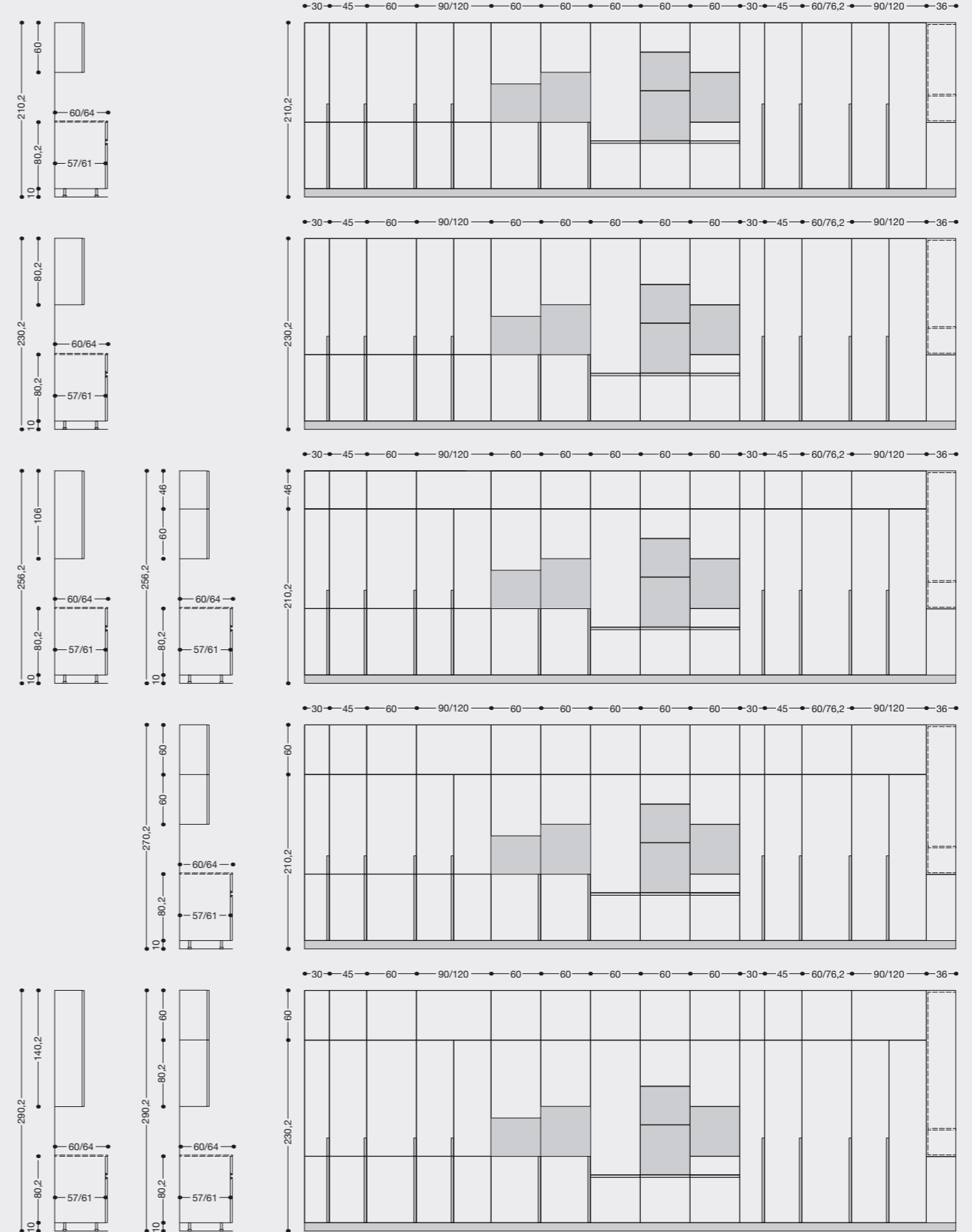

High_
ALTEZZA

210 cm

230 cm

256 cm

270 cm

290 cm

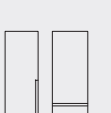
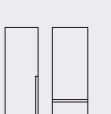
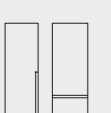
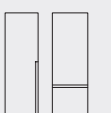
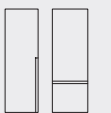

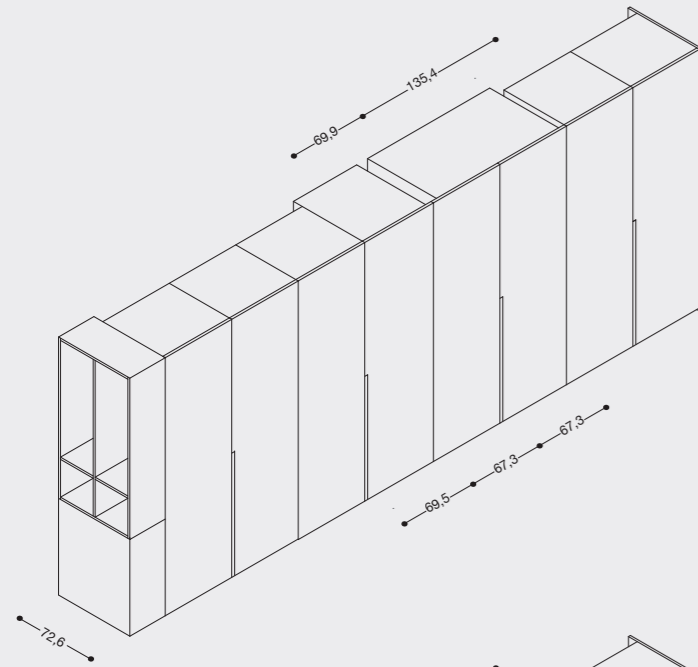

Closed retracting doors
width of single and double doors_
 ANTE RIENTRANTI CHIUSE
 LARGHEZZA DELLE ANTE SINGOLE O
 DOPPIE

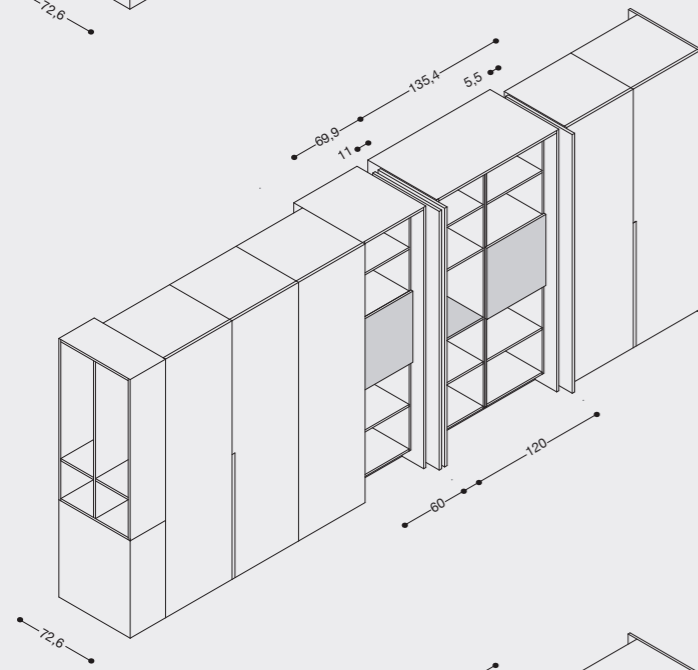

Open retracting doors
width of the internal compartments_
 ANTE RIENTRANTI APERTE
 LARGHEZZA DEI VANI INTERNI

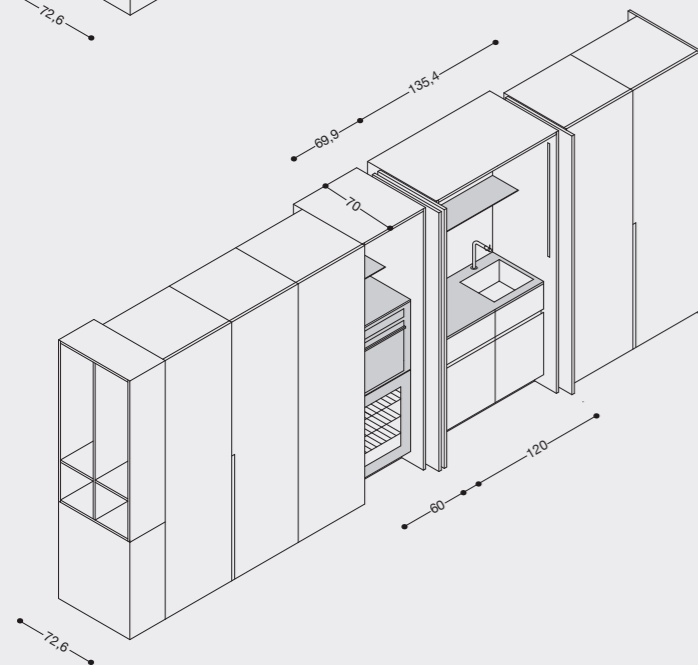

Comprehensive open retractive doors
overall width_
 ANTE RIENTRANTI APERTE
 LARGHEZZE COMPLESSIVE

Cupboards with hide away doors for integration with internal modules_

ARMADIATURE CON ANTE RIENTRANTI PER INTEGRAZIONE CON MODULI INTERNI

Si tratta di eleganti e funzionali armadiature che trasformano lo spazio cucina in zona living in cui ricevere e sorprendere gli ospiti: sono infatti la soluzione perfetta per far scomparire le zone tecniche della cucina.

Tutto è doppio per arredare, divertire, intrattenere, per cucinare e poi nascondere. Ad ante aperte infatti compaiono le colonne dedicate ai forni, ai piccoli elettrodomestici, alle zone lavaggio e/o operative in genere. Molteplici sono le combinazioni possibili per la zona interna: dalle più semplici ottenute con i soli ripiani a vere e proprie composizioni preziose complete di basi, pensili, boiserie, luci interne, ecc.

Ad ante chiuse tutto appare immediatamente in perfetto ordine. I componenti tecnologici di alta

qualità agevolano la funzionalità di questa soluzione che permette di far scomparire nei fianchi le ante aperte e di non ostacolare l'operatività di chi sta cucinando. L'ampia scelta di maniglie abbinata alla disponibilità delle molteplici finiture permette il loro facile inserimento in progetti dai diversi mood.

These are elegant and functional cupboards that transform the kitchen space into a living area in which to surprise your guests: they are the ideal solution to hide away working areas of the kitchen.

Everything is doubled to furnish, enjoy, entertain, cook and hide. With the doors open, the oven and small appliance,

sink and operational areas in general are on show. There are many possible combinations for the internal area: from the most simple, obtained by using only shelves, to more complex compositions complete with bases, shelves, wood panels, internal lights, etc.

With the doors closed, everything is tidied away immediately.

The high quality technological components make for easy use of this solution, which allows the open doors to be hidden away and not hinder the movement of busy cooks. The wide range of matching handles available in the many finishes allow them to be easily inserted into many different mood projects.

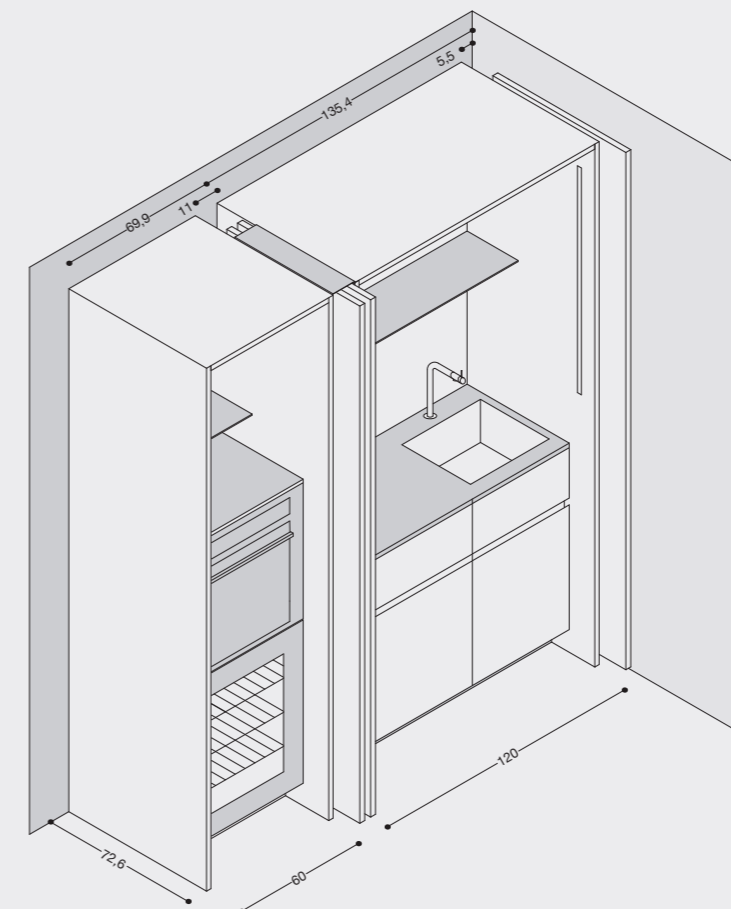

The Minimal_

EASY



CUCINA PRINCIPALE_
MAIN KITCHEN

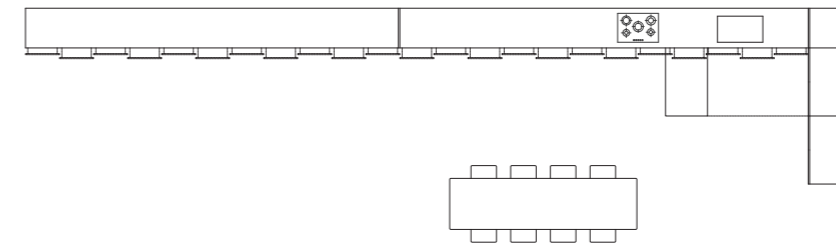

CUCINA SECONDARIA_
UTILITY KITCHEN

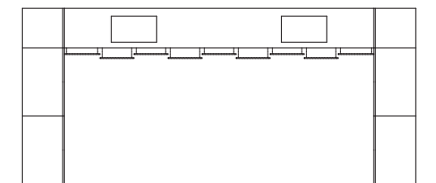

BASI / TOP_
BASE UNITS / TOP



Gres Fokos sale
Gres Fokos salt



Glaks G060 sasso
Glaks G060 stone



Acciaio
Stainless steel

TAVOLO SCORREVOLE_
SLIDING TABLE



Acciaio
Stainless steel

COLONNE_
TALL UNITS



Gres Fokos sale
Gres Fokos salt

















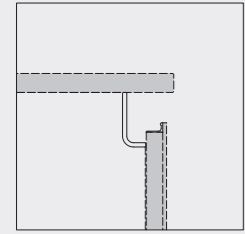

Easy frame door_

EASY ANTA TELAIO

Base units_

BASI

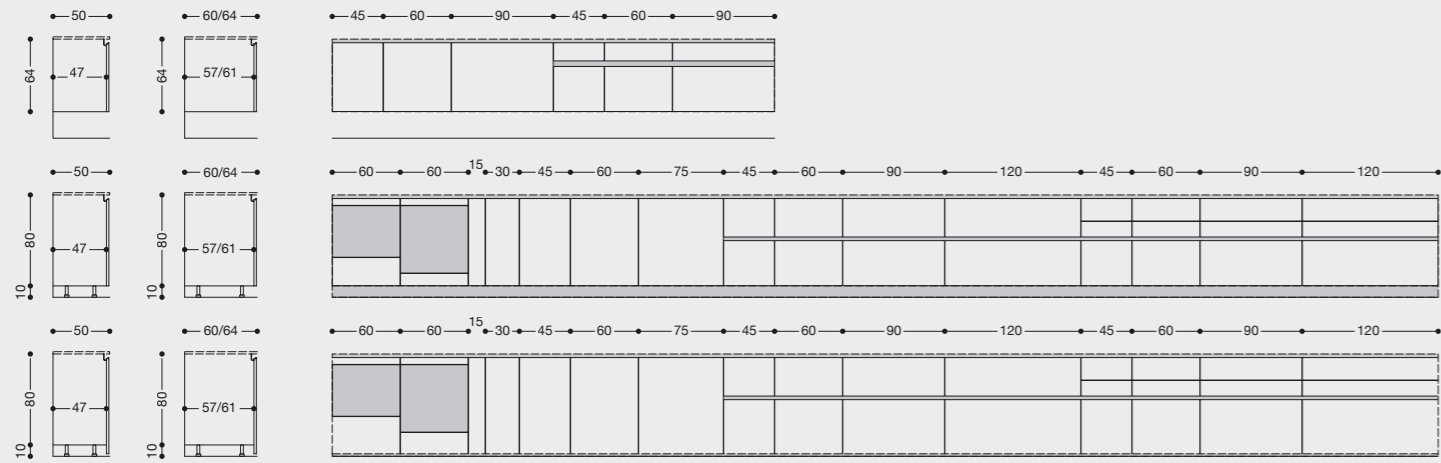

Wall units_

ELEMENTI A MURO



High_

ALTEZZA

64 cm

90,2 cm

90,2 cm

High_

ALTEZZA

46 cm

60 cm

80,2 cm

106,2 cm

140,2 cm

Alignements wall units and tall units_

ALLINEAMENTO UNITÀ A MURO E COLONNE

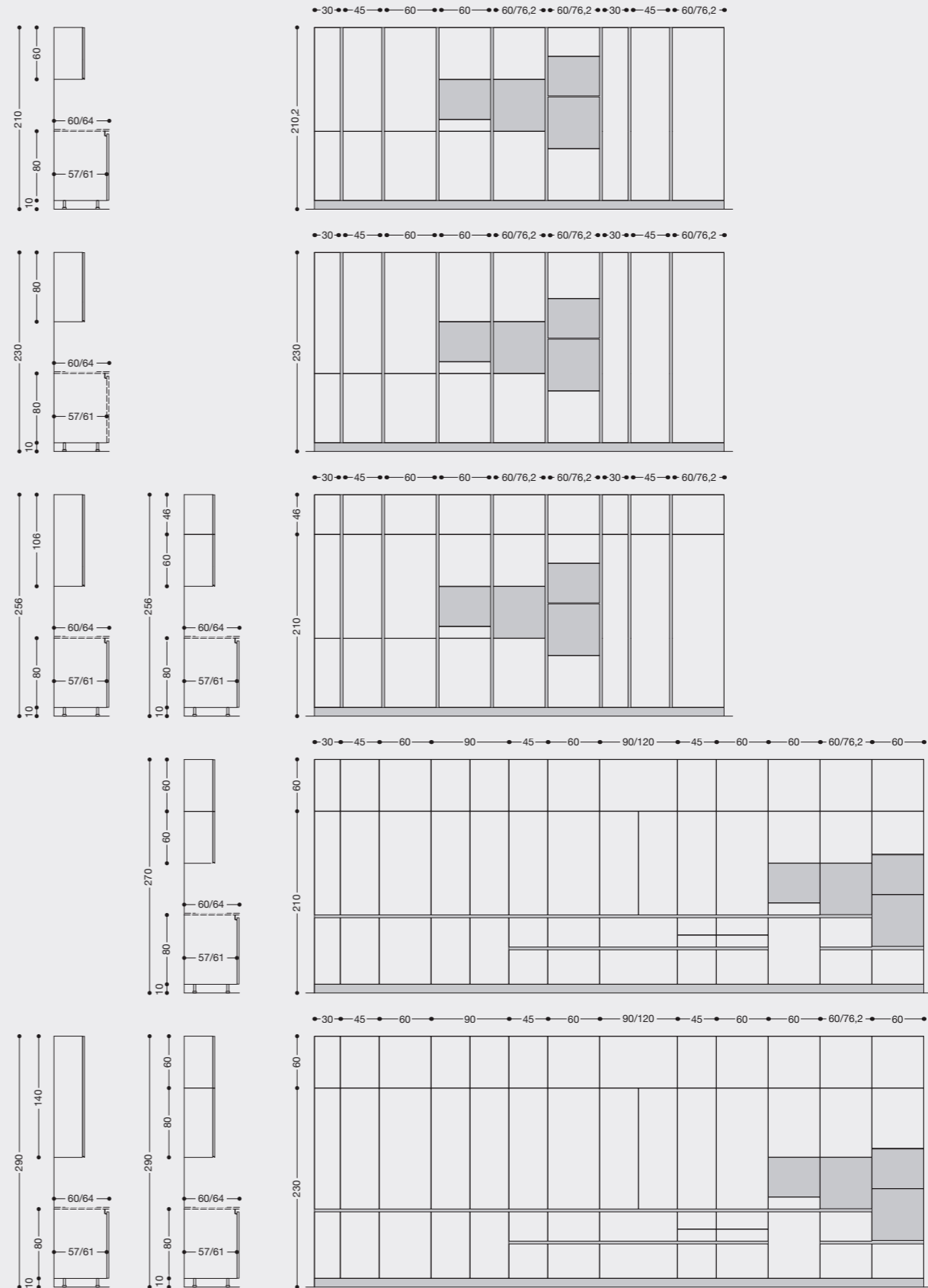

High_

ALTEZZA

210 cm

230 cm

256 cm

270 cm

290 cm



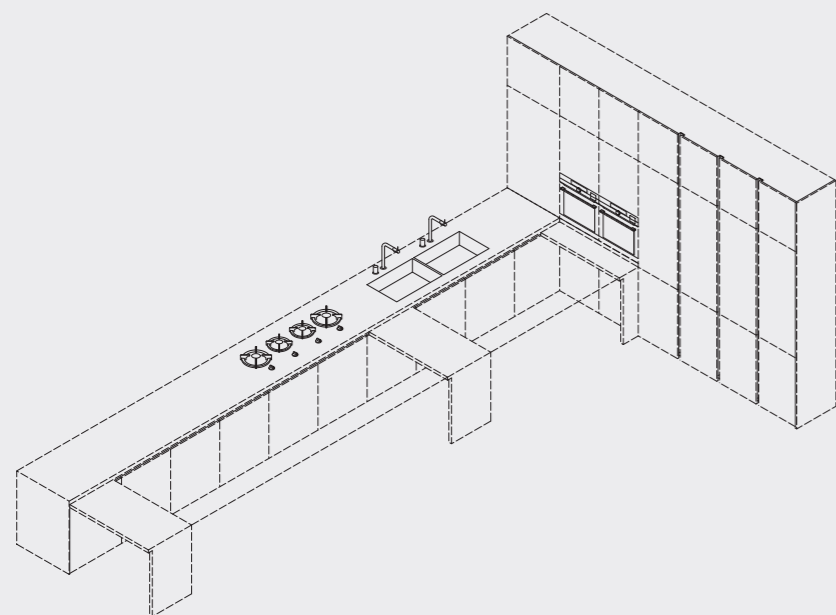

Composition with corner tall units_
COMPOSIZIONE CON COLONNE AD ANGOLO

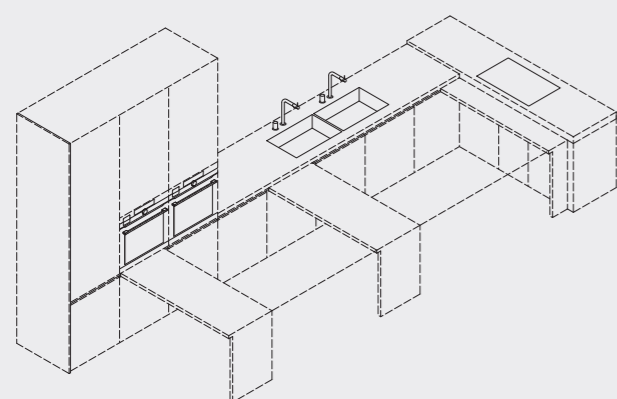

Composition with corner base units_
COMPOSIZIONE CON BASI AD ANGOLO

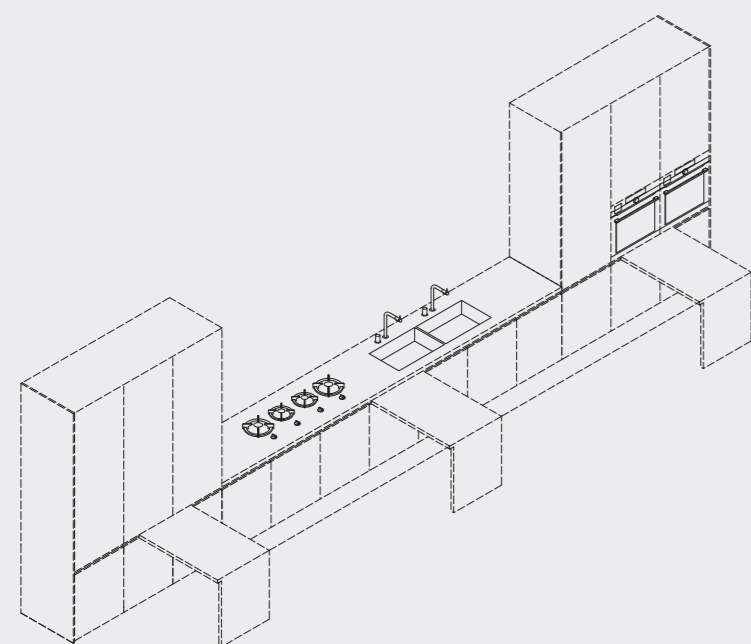

Linear composition_
COMPOSIZIONE LINEARE

Sliding Table_

SLIDING TABLE

Sliding Table è un brevetto tecnico Elmar registrato e certificato catas per 30.000 cicli di apertura con 50 kg di carico uniformemente distribuito.

Si tratta di un tavolo che può scorrere lungo tutta la composizione e in posizione di riposo scompare al di sotto del normale piano di lavoro oppure nell'apposito vano creato a colonna, lasciando a vista solo la sporgenza necessaria per la presa maniglia.

E' composto da un fianco dotato di ruote con freno e da un piano di lavoro disponibile in due profondità fisse

(59-74) e con lunghezza progettabile a misura fino ad un massimo di 160 cm.

E' disponibile nelle finiture: acciaio scotch brite, acciaio wirbel steel, e in lamiera verniciata bianca.

Sliding table is an Elmar technical patent, Catas registered and certified for 30,000 opening cycles with a uniformly distributed load of 50 kg.

This table can slide along the entire kitchen composition and when it's in

the resting position it disappears under the normal worktop or in the designated column compartment, thus leaving only the protrusion required for the handle.

It consists of a side equipped with wheels with brake and a worktop available in two fixed depths (59-74) and with a length designed to measure up to a maximum of 160 cm.

It is available in the following finishes: Scotch Brite steel, Wirbel steel and white painted sheet.

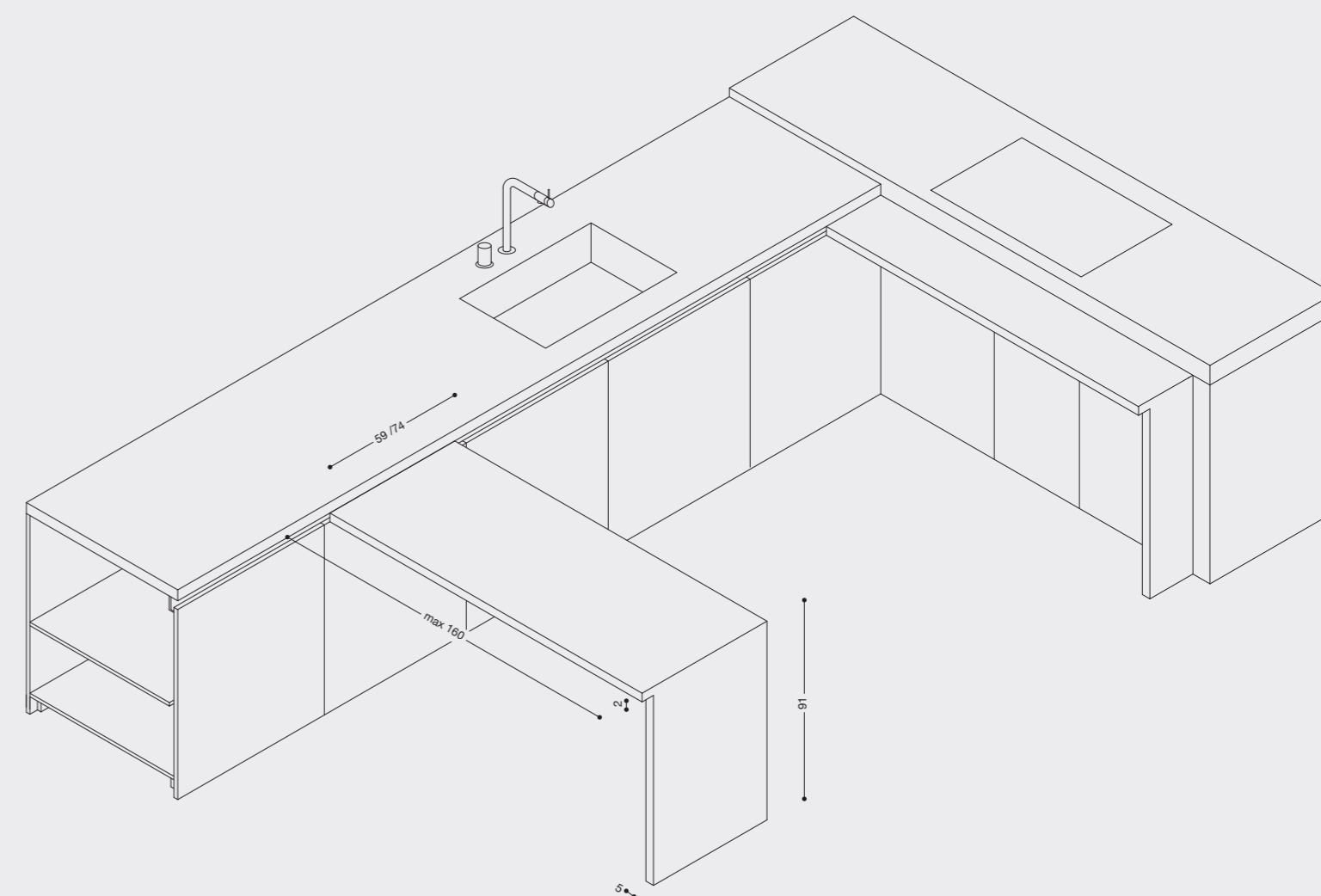



The Loft_

@HOME

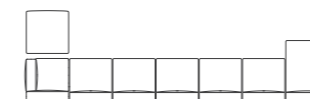
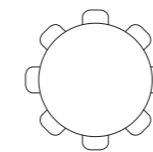
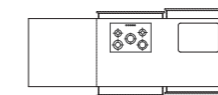

ISOLA / TOP_

ISLAND / TOP



Acciaio
Stainless steel



Acciaio finitura titanio scuro
Stainless steel dark titanium
finish

COLONNE_

TALL UNITS



Acciaio finitura titanio scuro
Stainless steel dark titanium
finish











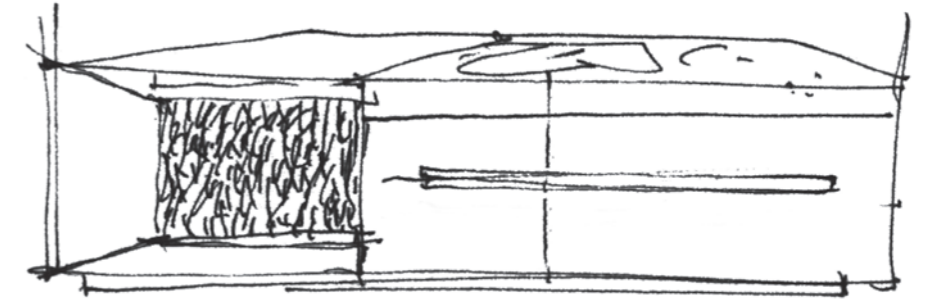



.elmar

@home Details

89



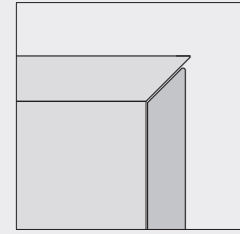

@Home_@HOME

Wall units_ ELEMENTI A MURO

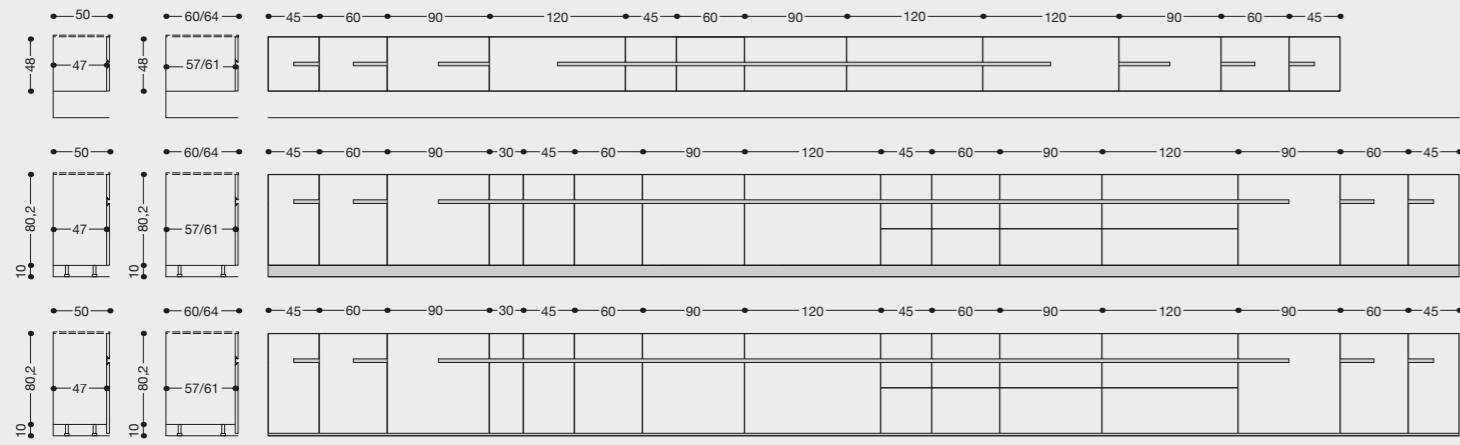

Wall units_ ELEMENTI A MURO

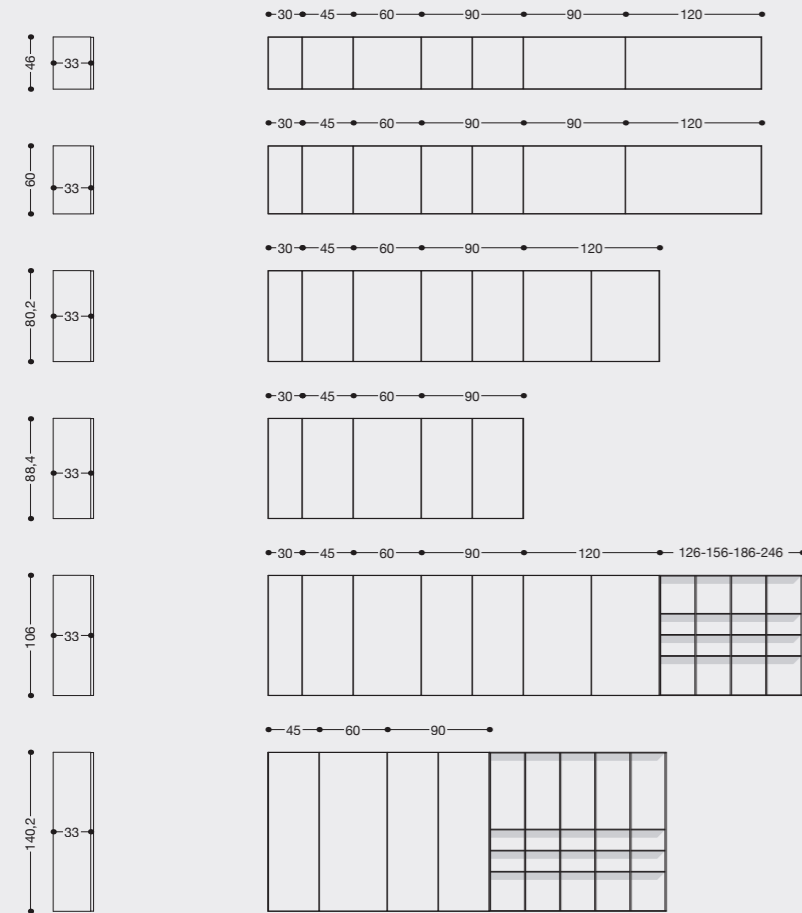

High_ ALTEZZA

48 cm

90,2 cm

90,2 cm

High_ ALTEZZA

46 cm

60 cm

80,2 cm

88,4 cm

106,2 cm

140,2 cm

Allineamenti wall units and tall units_ ALLINEAMENTO UNITÀ A MURO E COLONNE

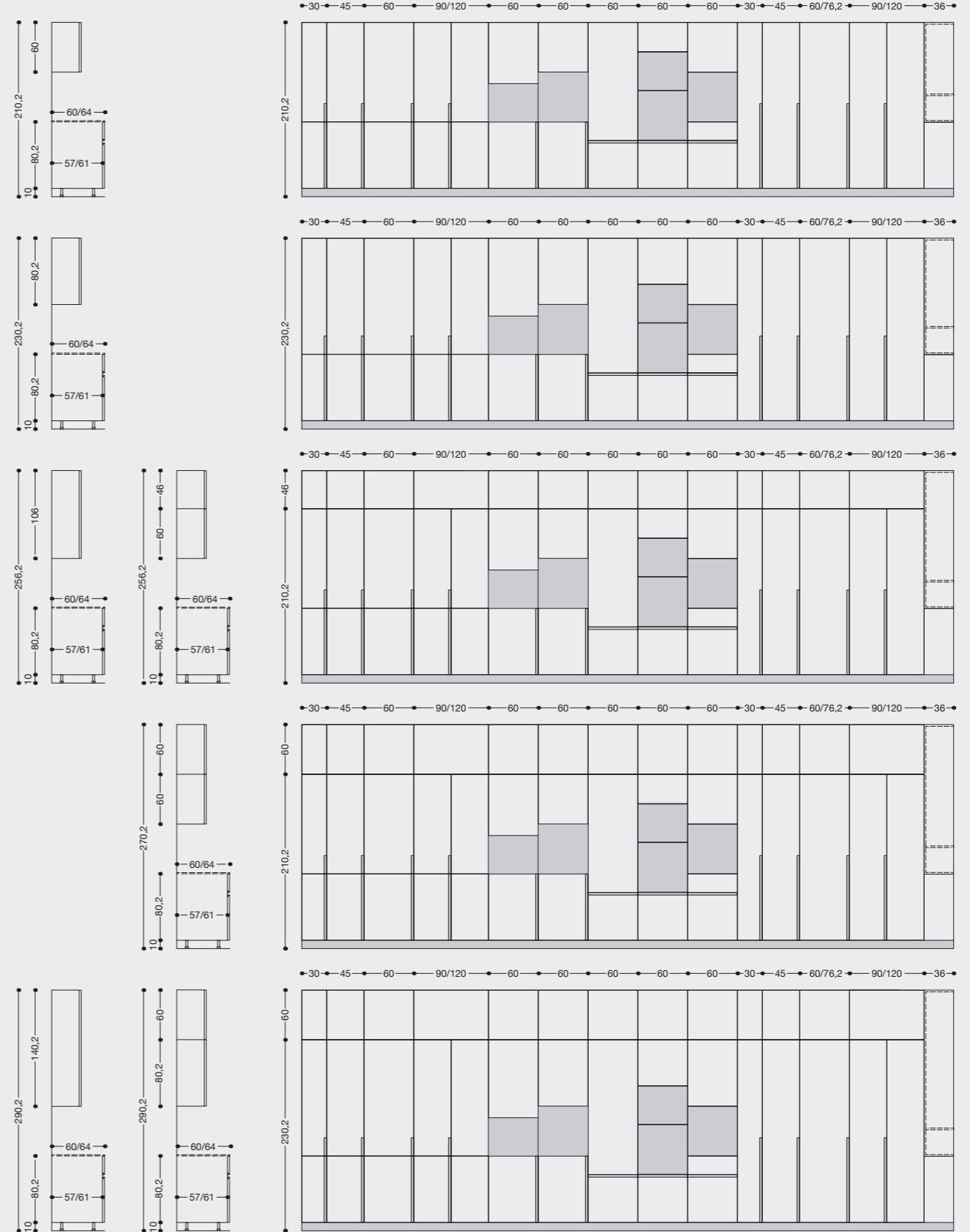

High_ ALTEZZA

210 cm

230 cm

256 cm

270 cm

290 cm

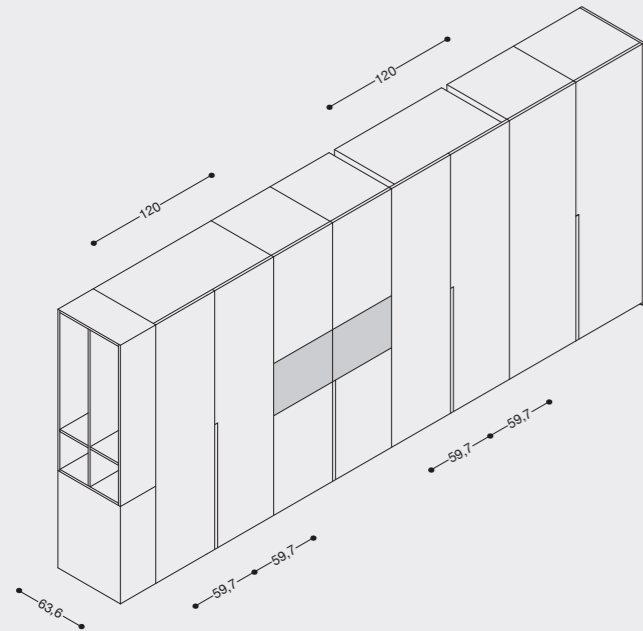

Closed Gourmet tall units_
COLONNE GOURMET CHIUSE

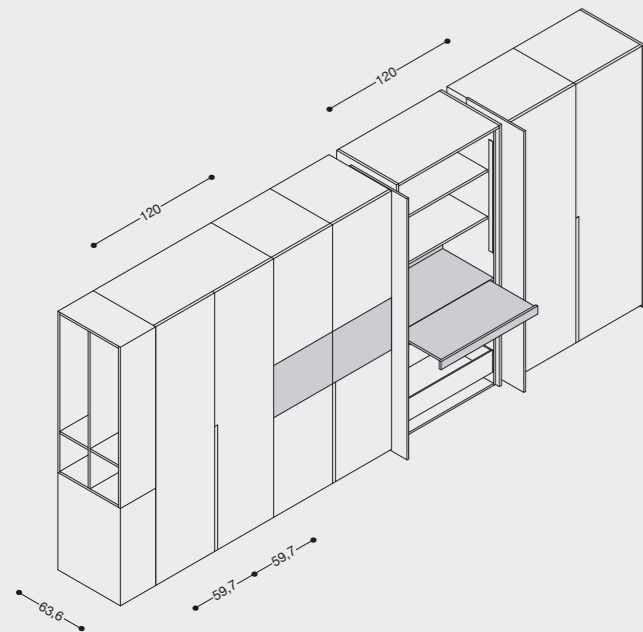

Gourmet tall units with open retracting doors_
COLONNE GOURMET CON ANTE RIENTRANTI APERTE

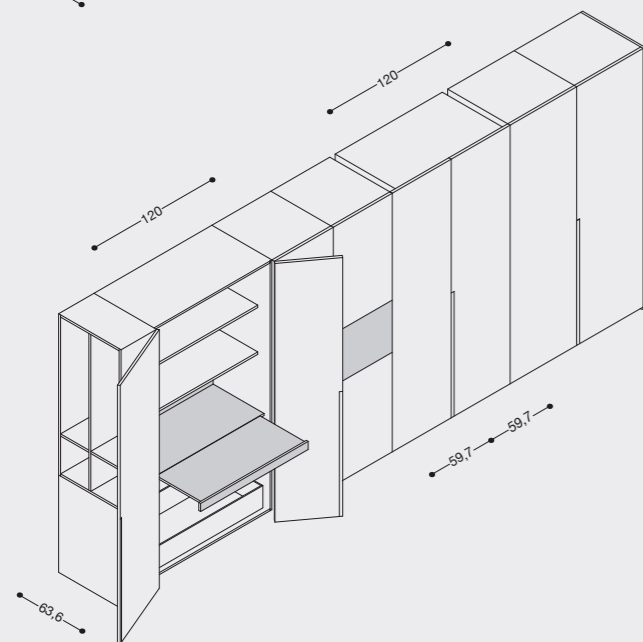

Gourmet tall units with two opening systems_
COLONNE GOURMET CON ANTE A BATTENTE APERTE

Island 0_

ISOLA 0

Quando le cucine sono aperte alla convivialità si distinguono per il design, per la funzionalità e per l'estrema qualità dei materiali.

La forza espressiva dell'isola 0 nasce dalla ricerca della semplicità raggiunta attraverso un lavoro di sottrazione e semplificazione senza nulla togliere alla funzionalità.

La tecnologia ci permette oggi di lavorare l'acciaio in spessori minimi sia in verticale che in orizzontale, di integrare perfettamente lavello e piano cottura e di poter scegliere tra finiture con molteplici effetti tattili.

When kitchens are open for conviviality they are distinguished by design, usability and for the extremely high quality of materials used.

The expressive force of Isola 0 is born from the quest for simplicity, achieved by taking bits away and simplifying without harming usability.

This technology allows us to work the steel to minimal thickness, both vertically and horizontally, perfectly integrating the sink and hob whilst choosing from the many finishes and surfaces.

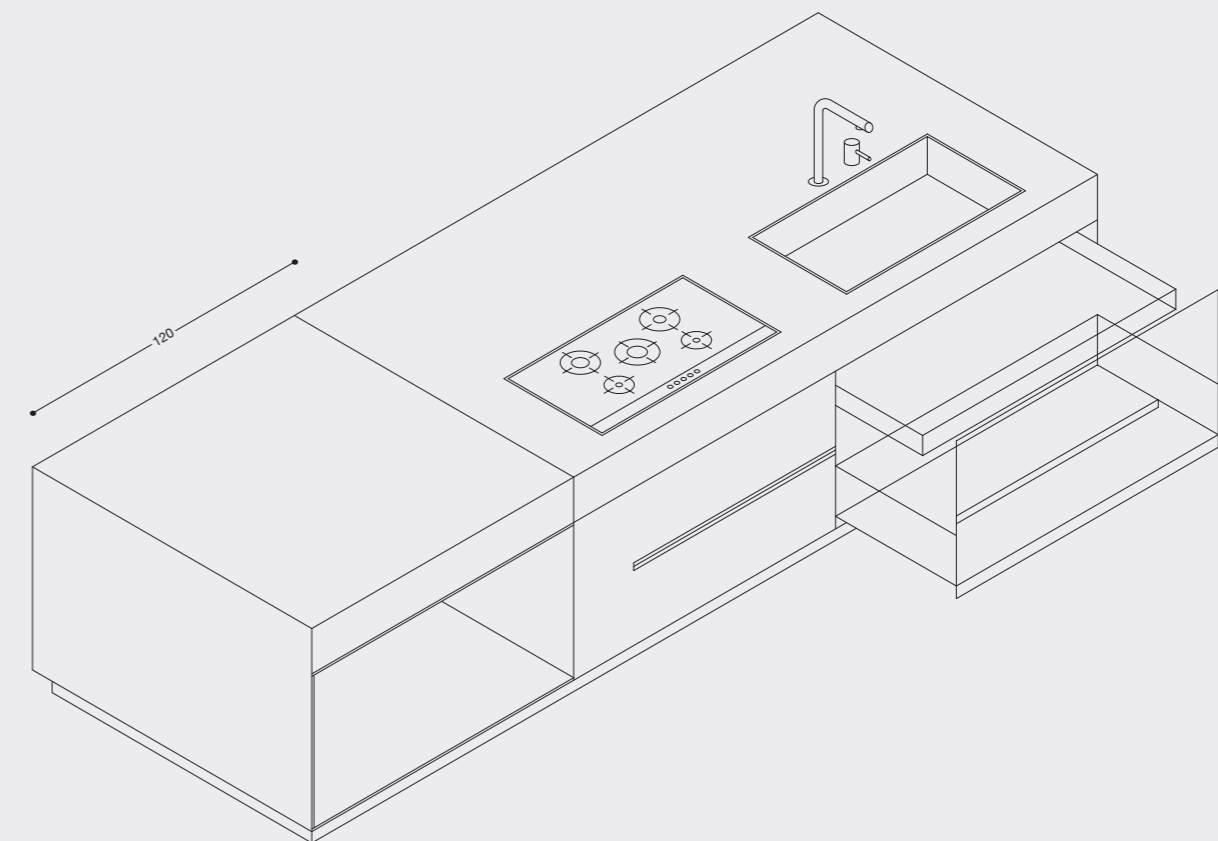

The Open Air_

SLIM

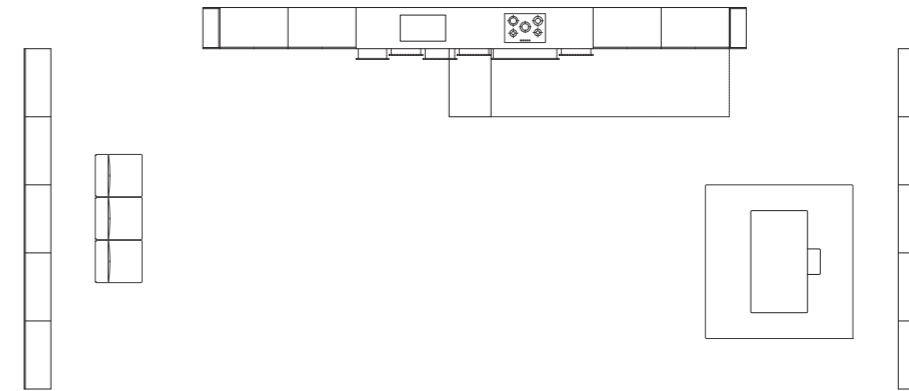

BASI / TOP_
BASE UNITS / TOP



LG Bianco Alpino
LG Alpine white



Laccato bianco opaco 7000
White matt lacquer 7000

COLONNE_
TALL UNITS



Laccato bianco opaco 7000
White matt lacquer 7000

SLIDING TABLE_
SLIDING TABLE



Bianco
White

BOISERIE_
BOISERIE



Laccato bianco opaco 7000
White matt lacquer 7000



Alluminio
Aluminium













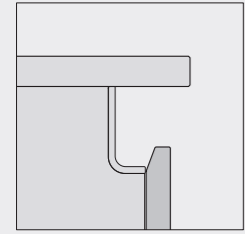

Slim SLIM

Wall units ELEMENTI A MURO

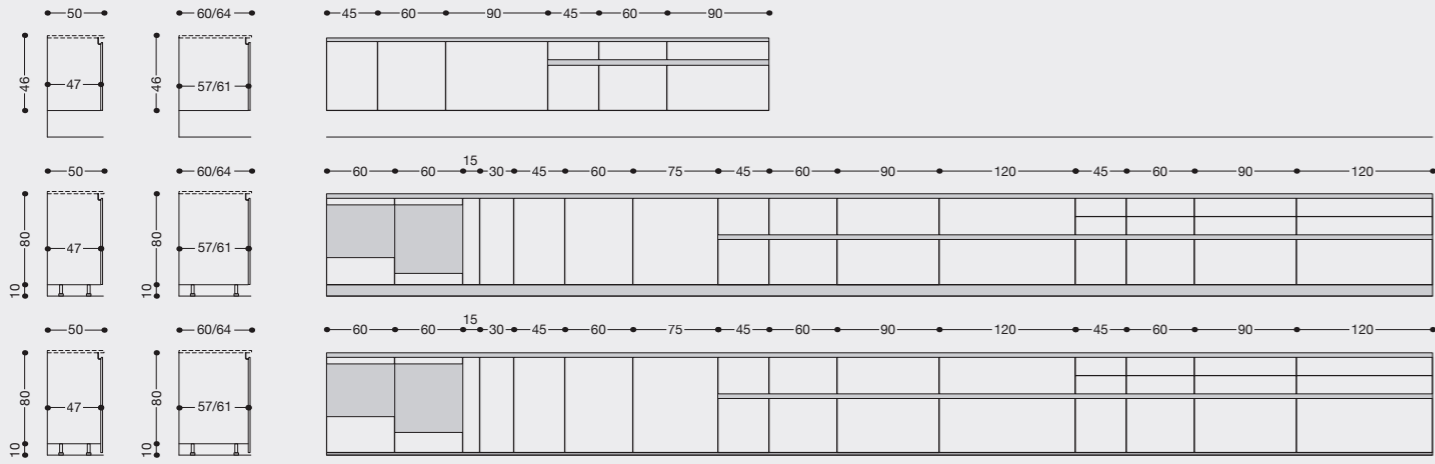

Wall units ELEMENTI A MURO



High ALTEZZA

64 cm

90,2 cm

90,2 cm

High ALTEZZA

46 cm

60 cm

80,2 cm

106,2 cm

142 cm

Allineamenti wall units and tall units ALLINEAMENTO UNITÀ A MURO E COLONNE

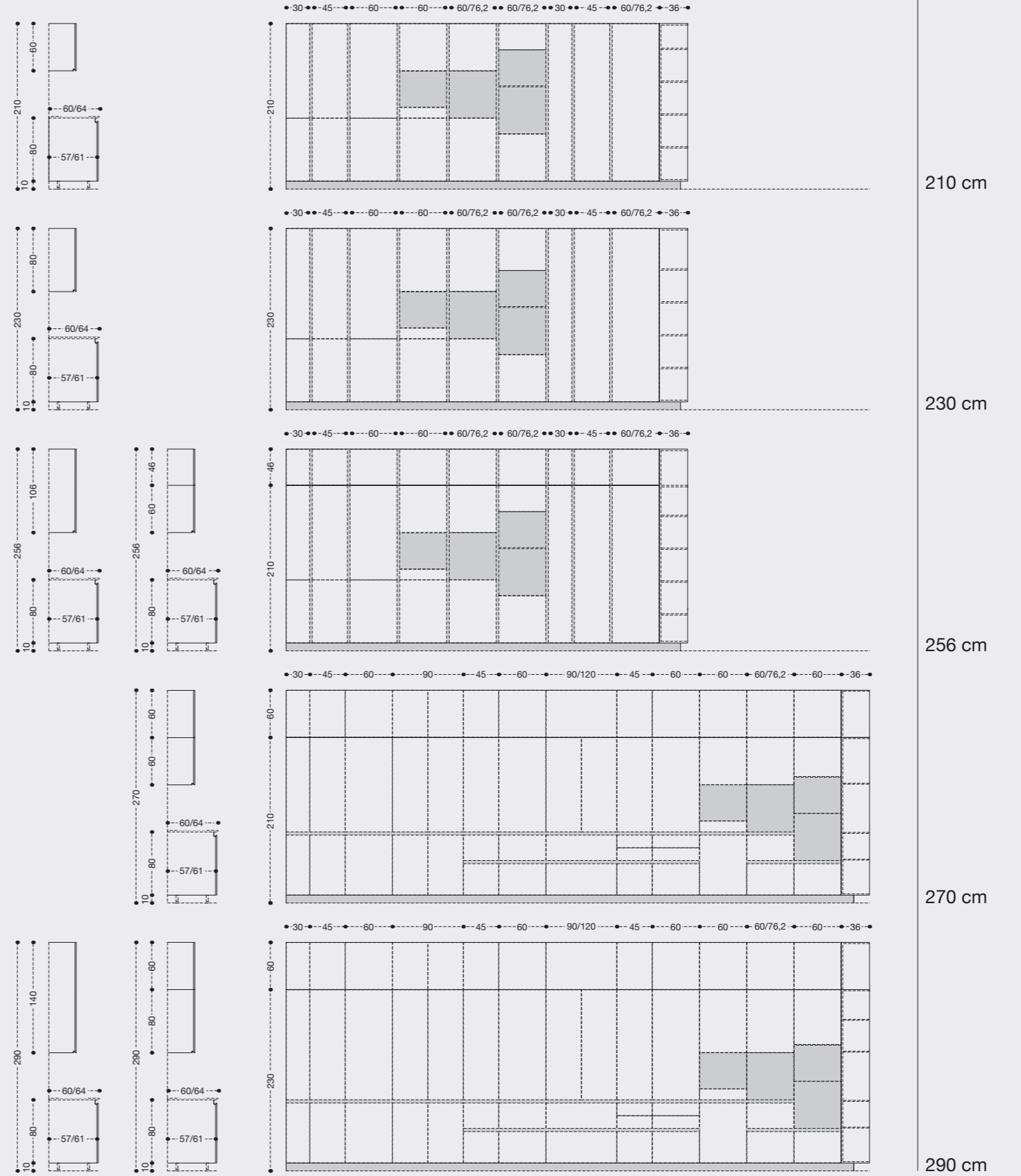

High ALTEZZA

210 cm

230 cm

256 cm

270 cm

290 cm

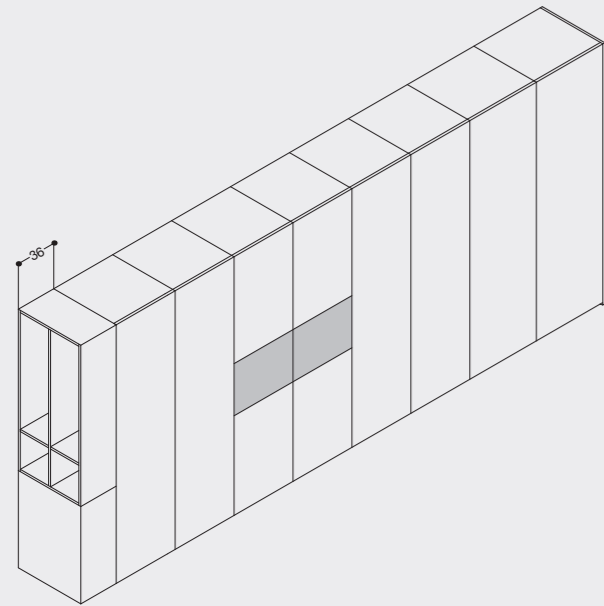

Open terminal tall unit made by a closed base and by an open storage unit_

COLONNA TERMINALE APERTA NELLA ZONA SUPERIORE E CON VANO APRIBILE INFERIORE

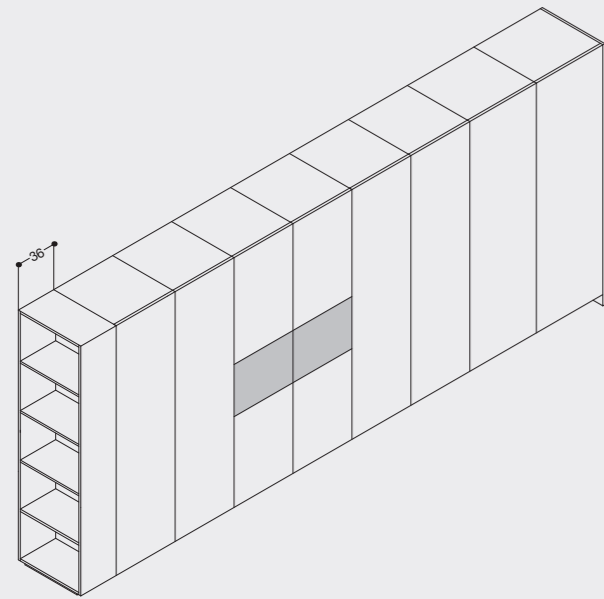

Open terminal tall unit with equidistant shelves_

COLONNA TERMINALE COMPLETAMENTE APERTA CON VANI EQUIDISTANTI

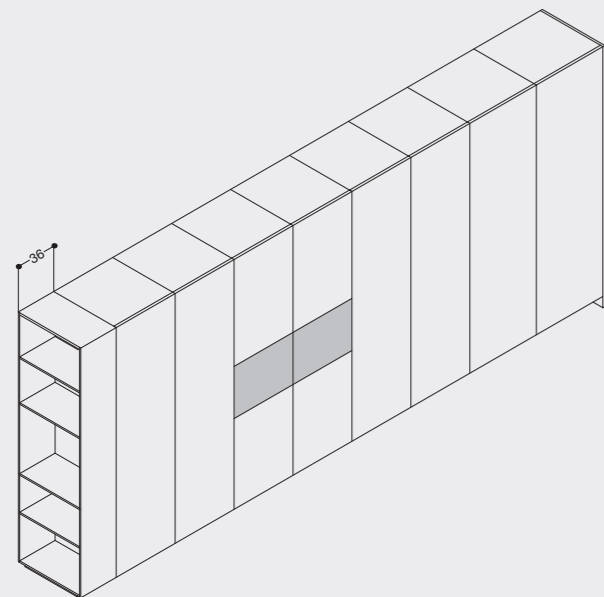

Open terminal tall unit, with a larger central compartment_

COLONNA TERMINALE COMPLETAMENTE APERTA CON VANO CENTRALE PIÙ AMPIO

Open Terminal Columns_

COLONNE TERMINALI A GIORNO

Sono i moduli ideali per impreziosire il passaggio tra due ambienti comunicanti ed ammorbidire l'impatto del fianco di una colonna o di una serie di colonne.

Possono contenere o mostrare, offrire e servire. Sono elementi che si arricchiscono attraverso la personalità e la storia di chi li usa. Sono disponibili in molteplici finiture, in due configurazioni di serie personalizzabili.

These modules are ideal to embellish the passage between two communicating spaces and to soften the impact of the side of a column or of a series of columns.

They can contain, display, offer and serve. These elements can be enriched through the personality and the history of those who use them. They're available in many finishes and in two standard configurations or customizable.

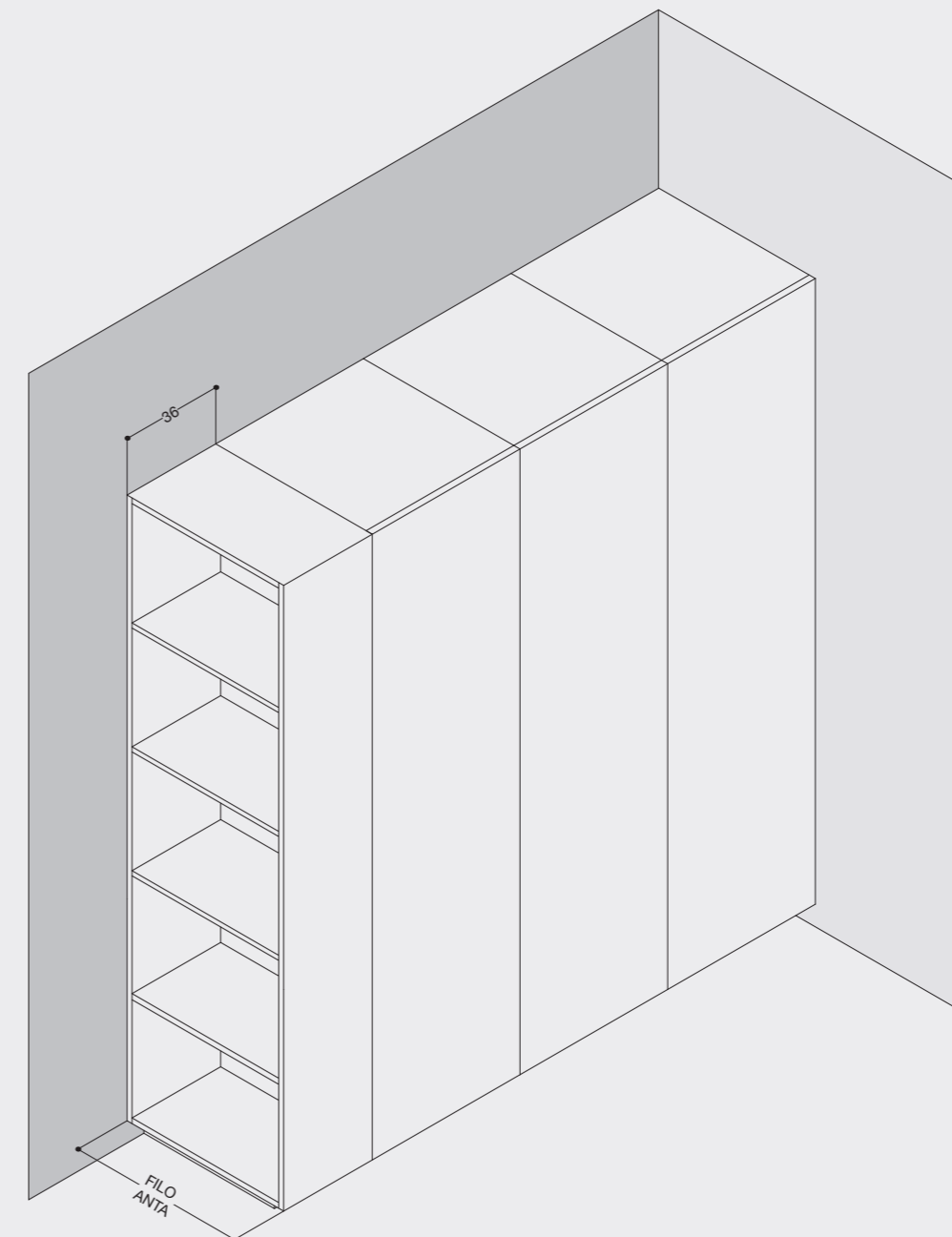

The lounge_

EL_01



CUCINA SECONDARIA_
UTILITY KITCHEN_EASY

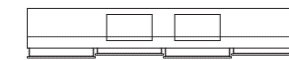

CUCINA PRINCIPALE_
MAIN KITCHEN

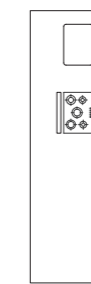
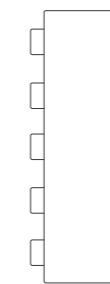
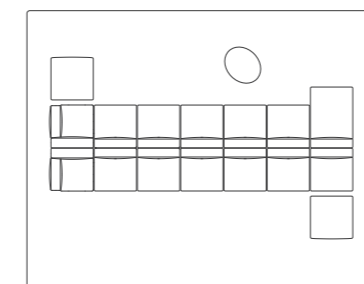
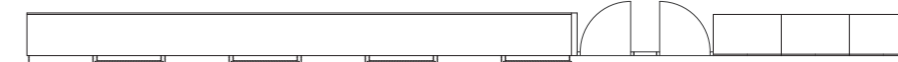
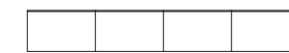

ISOLA E BASI_
ISLAND AND BASE UNITS



Laccatura metallica Rame
Metallic lacquer Copper



Glaks G029 Rosa
Glaks G029 Pink



Grey stone
Grey stone

COLONNE_
TALL UNITS



Rovere affumicato
Smokey oak



Glaks G029 Rosa
Glaks G029 Pink

TAVOLO E LIBRERIE_
TABLE AND SHELVES



Rovere affumicato
Smokey oak













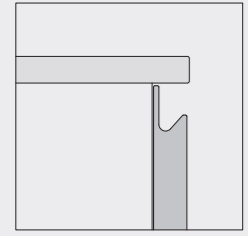

EL_01_ EL_01

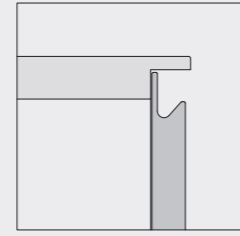

EL_01_ EL_01

Base units_ BASI

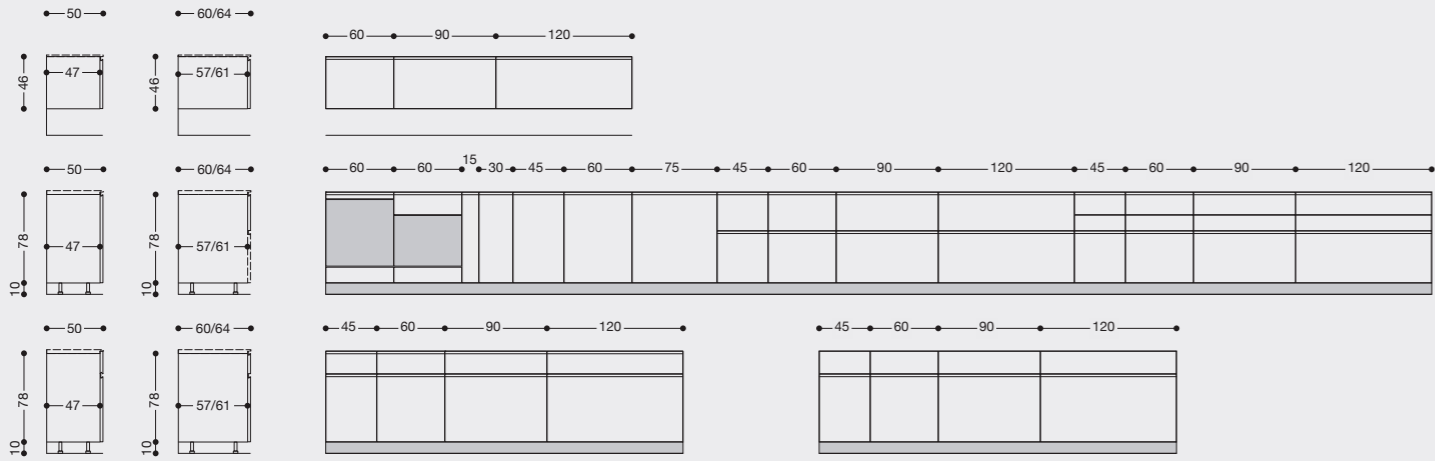

Wall units_ ELEMENTI A MURO

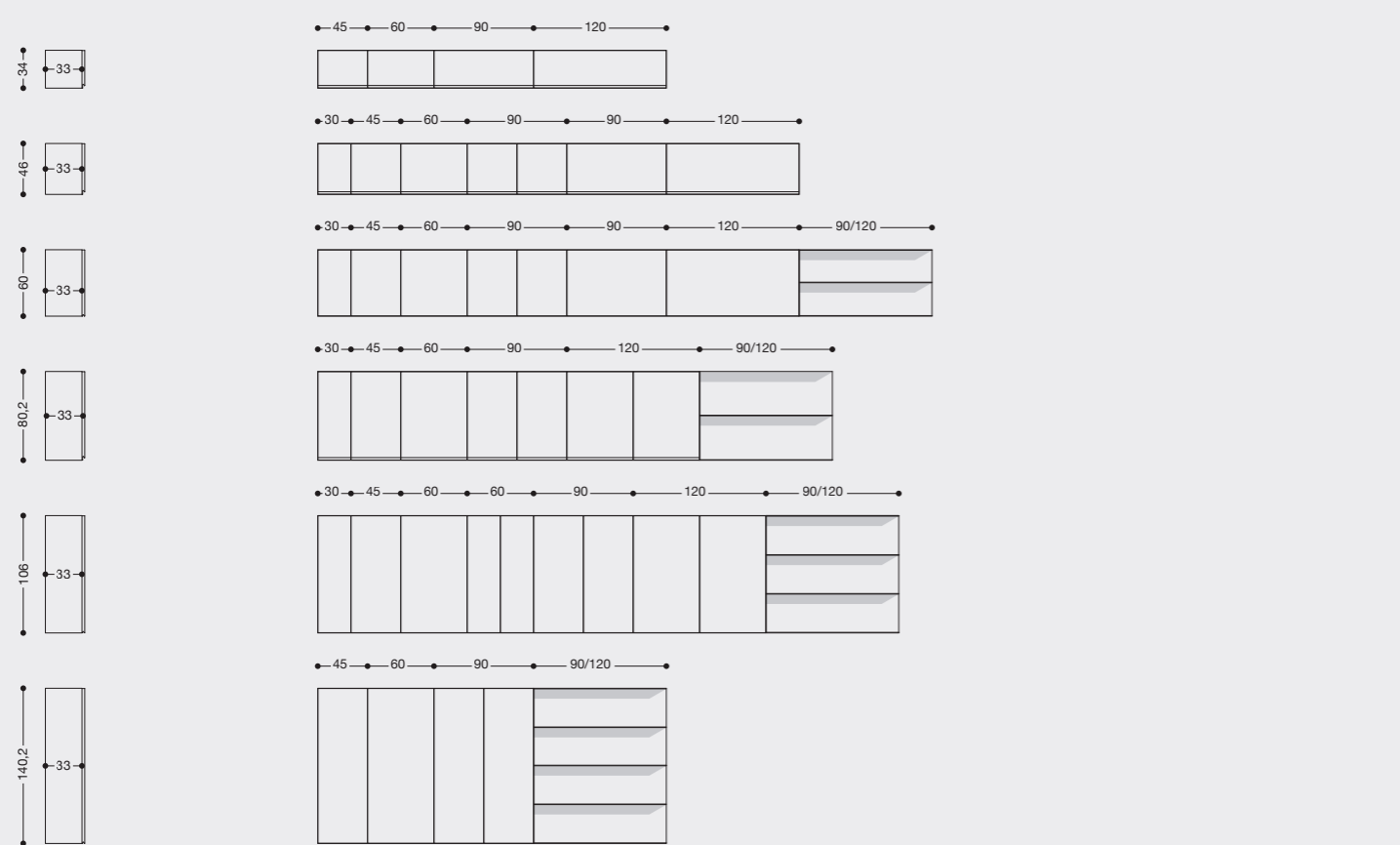

High_ ALTEZZA

46 cm

90,2 cm

90,2 cm

High_ ALTEZZA

34,2 cm

46 cm

60 cm

80,2 cm

106,2 cm

140,2 cm

Allineamenti wall units and tall units_ ALLINEAMENTO UNITÀ A MURO E COLONNE

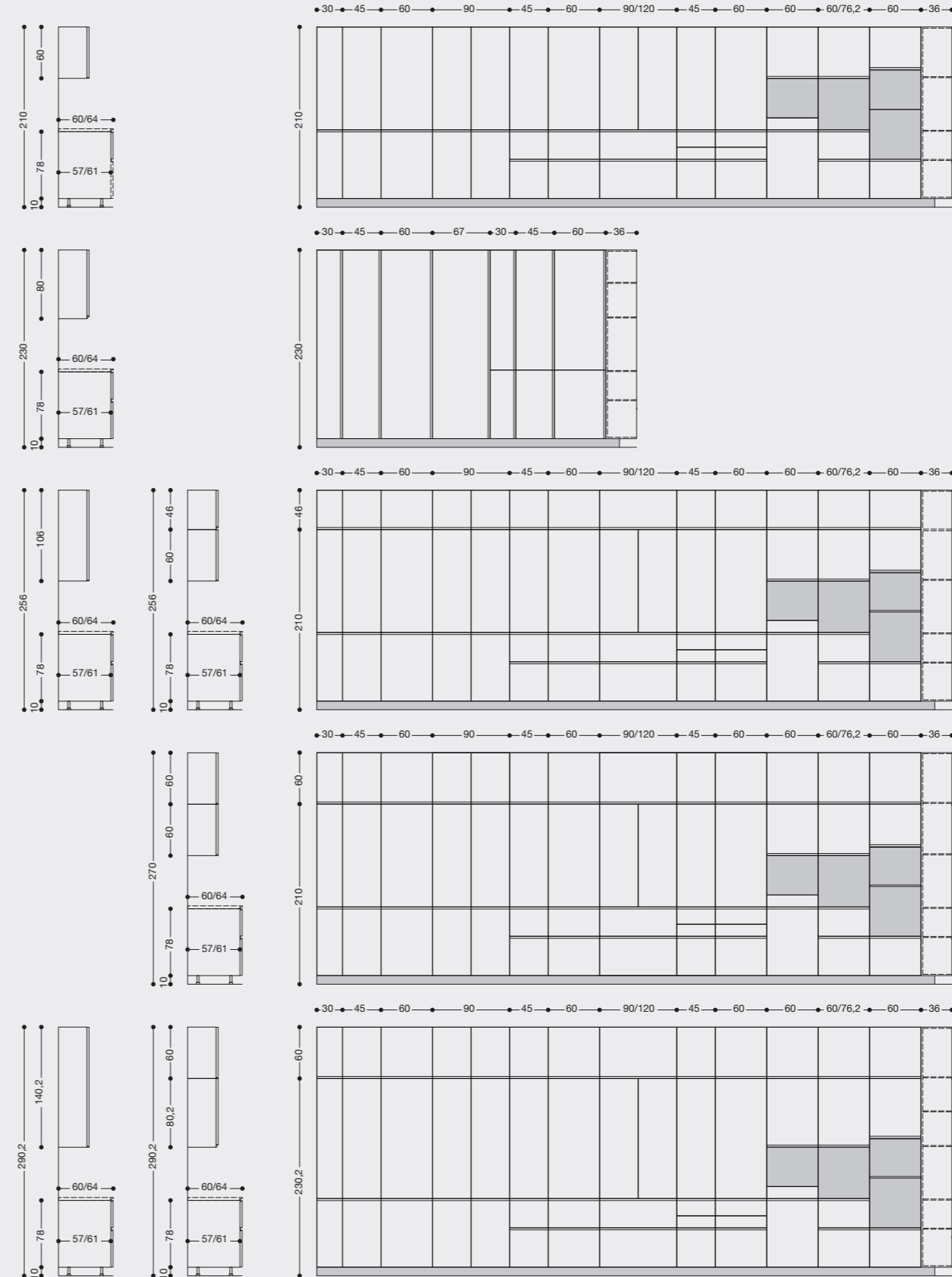

High_ ALTEZZA

210 cm

230 cm

256 cm

270 cm

290 cm

Wood Panelling_ BOISERIE

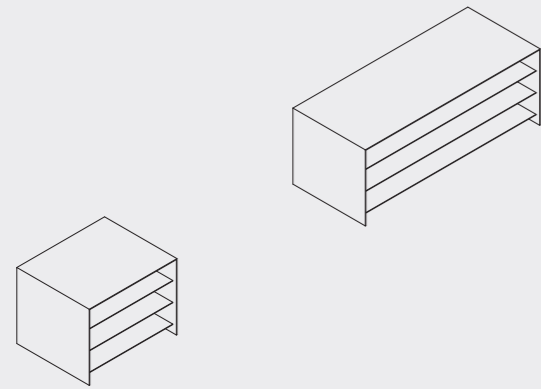

**Boiserie behind island_
BOISERIE RETRO ISOLA**

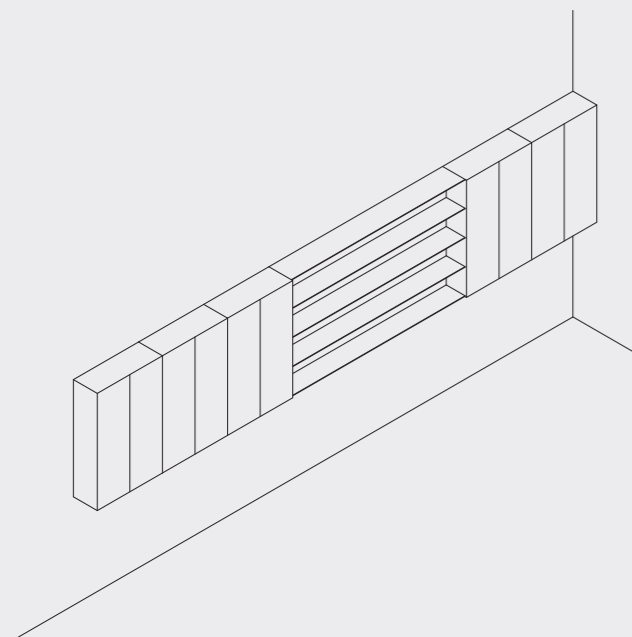

**Boiserie combined with wall units of
various heights_
BOISERIE ABBINATA AI PENSILI DI VARIE
ALTEZZE**

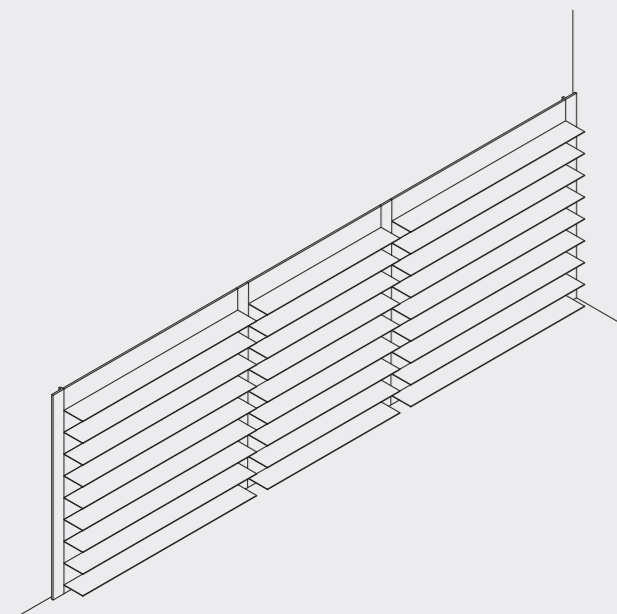

**Full wall panelling_
BOISERIE A TUTTA PARETE**

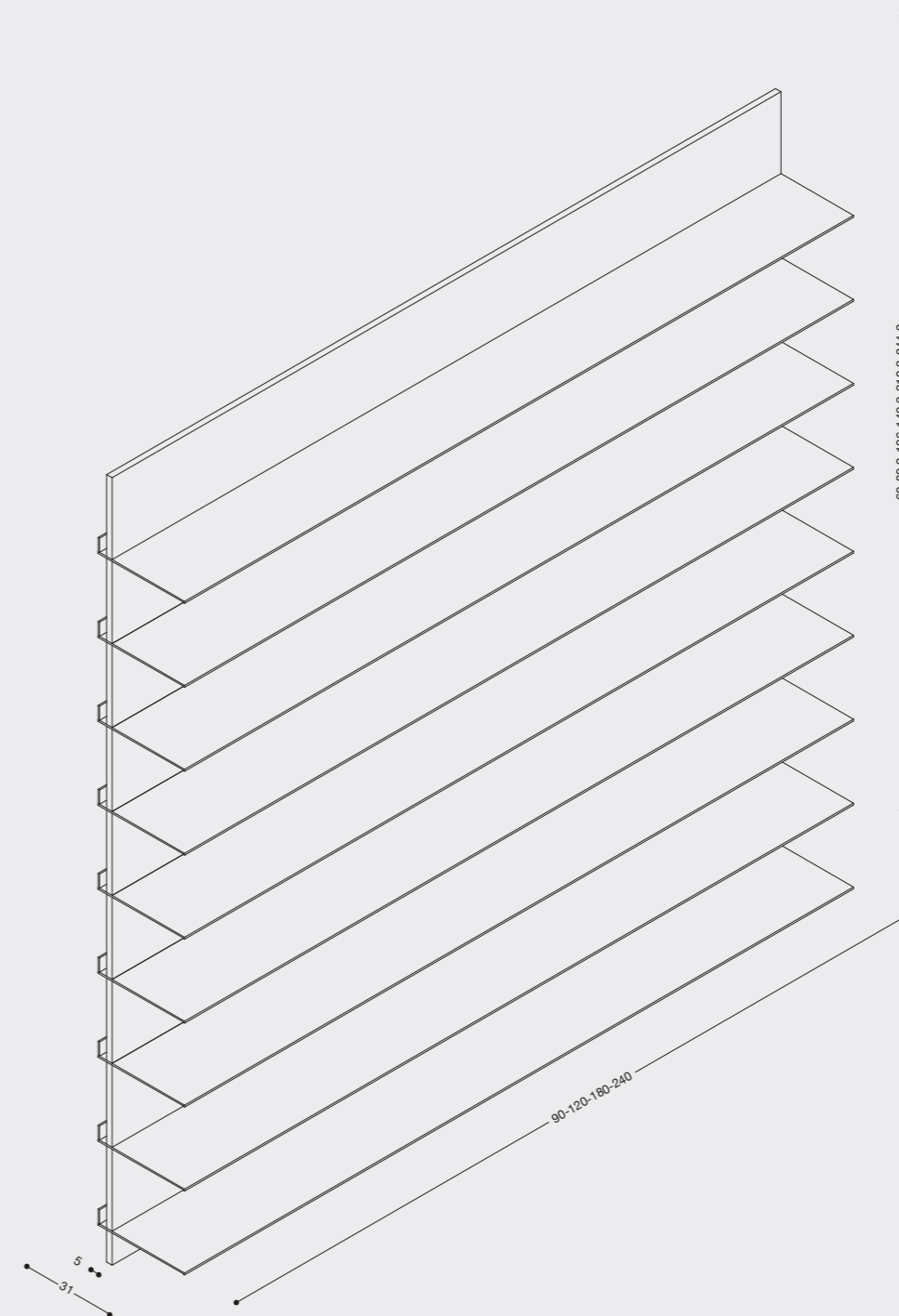

La tecnologia è stata integrata nella forma fino a diventare invisibile: così sono nate le sottilissime ma estremamente resistenti mensole della nostra boiserie.

Si tratta infatti di mensole in alluminio con spessore a vista di 8mm, elegantemente raggiate sugli spigoli e abbinabili agli schienali disponibili in oltre 200 varianti di finiture, dal decorativo al laccato opaco e lucido, dal legno pregiato alle molteplici finiture acciaio.

Ideali per arredare anche gli spazi living attigui alla cucina, si distinguono per l'elevata qualità, la durevolezza e l'eleganza formale.

Possono essere utilizzate per arredare intere pareti, per essere integrate ai pensili o per impreziosire il retro di un'isola o di una penisola.

This technology has been integrated into the design so as to become invisible: and so our extremely thin but resistant wood panel shelves are born.

They are in fact aluminium shelves with a visible thickness of 8mm, elegantly shining on the edges and can be paired with the backs available in over 200 finishing variants, from decorative to opaque and matte varnish, to precious wood and the many steel finishes.

Ideal for furnishing living spaces around the kitchen, they are notable for their high quality, durability and formal elegance.

They can be used for decorating entire walls, for integrating with shelves or for embellishing the back of an island or peninsular.

The playfull_

PLAYGROUND

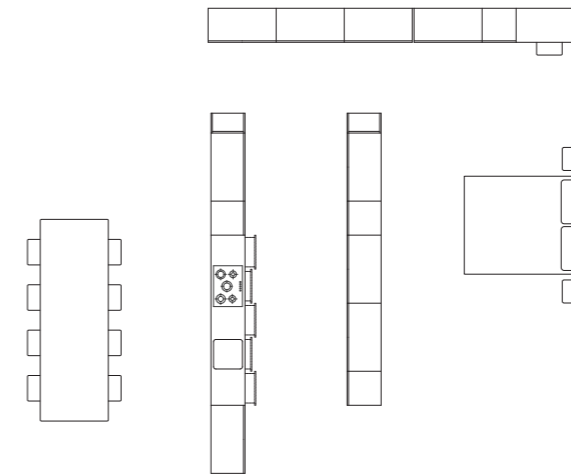

BASI E TOP_
BASE UNITS AND TOP



Laccato bianco opaco 7000
White matt lacquer 7000



Fenix bianco
White Fenix

COLONNE_
TALL UNITS



Laccato bianco opaco 7000
White matt lacquer 7000



1014 Mou opaco
1014 Matt mou



Laccato opaco rosso a campione
Red custom matt lacquered













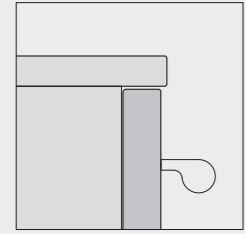

Playground_

PLAYGROUND

Wall units_

ELEMENTI A MURO

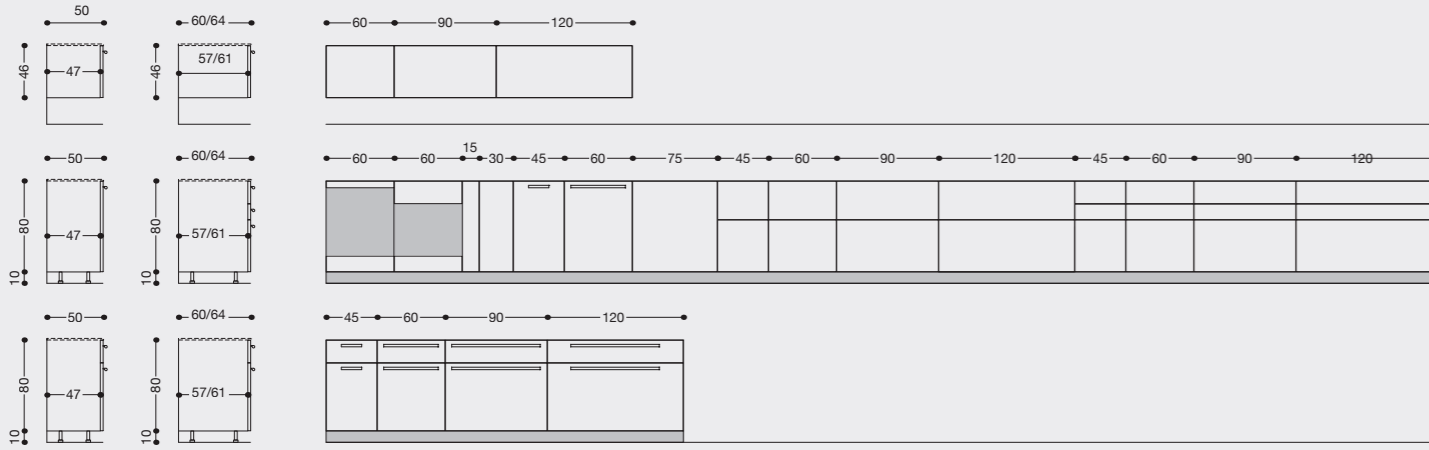

Wall units_

ELEMENTI A MURO

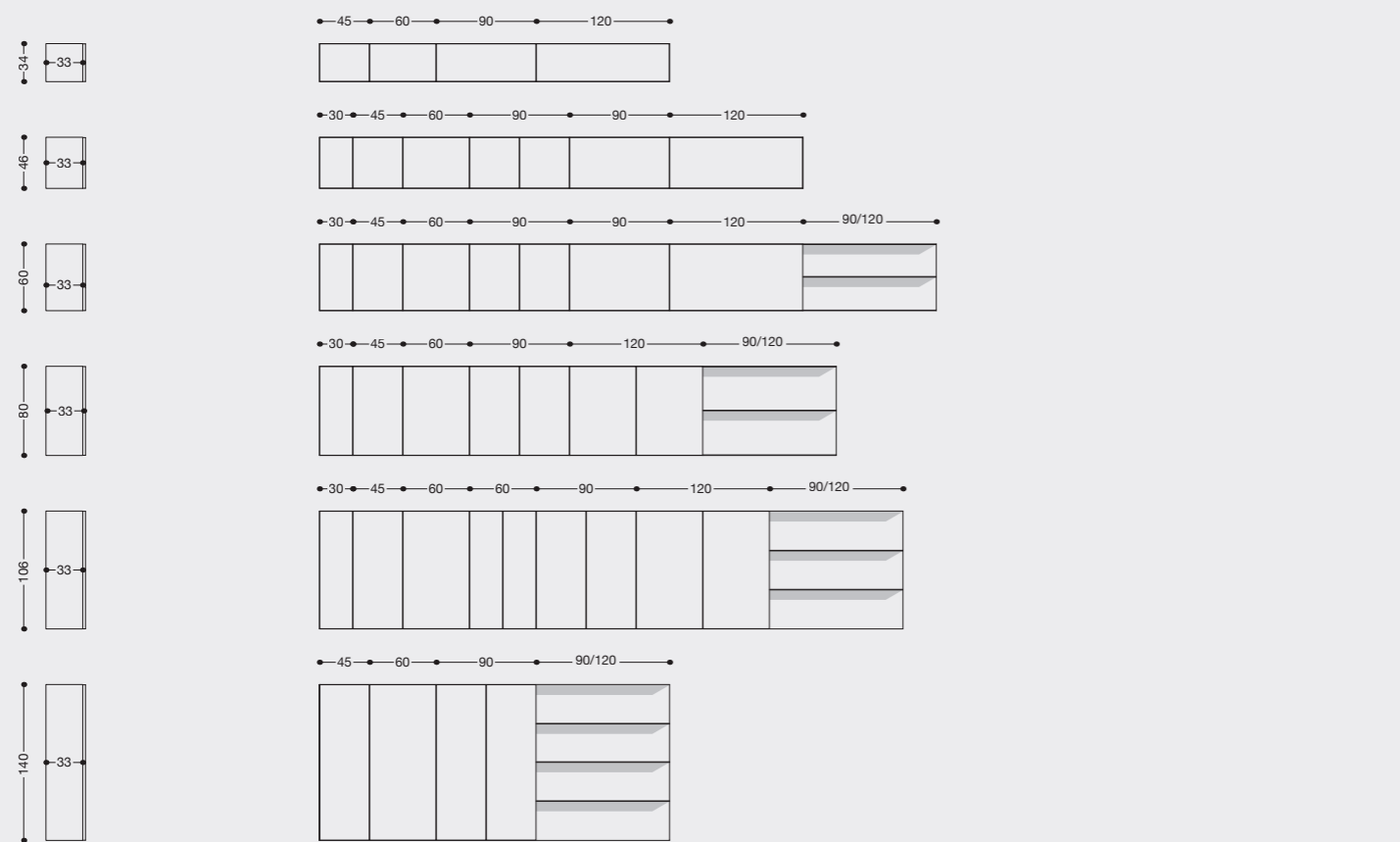

High_

ALTEZZA

46 cm

90,2 cm

90,2 cm

High_

ALTEZZA

34,2 cm

46 cm

60 cm

80,2 cm

106,2 cm

140,2 cm

Alignements wall units and tall units_

ALLINEAMENTO UNITÀ A MURO E COLONNE



High_

ALTEZZA

210 cm

230 cm

256 cm

270 cm

290 cm

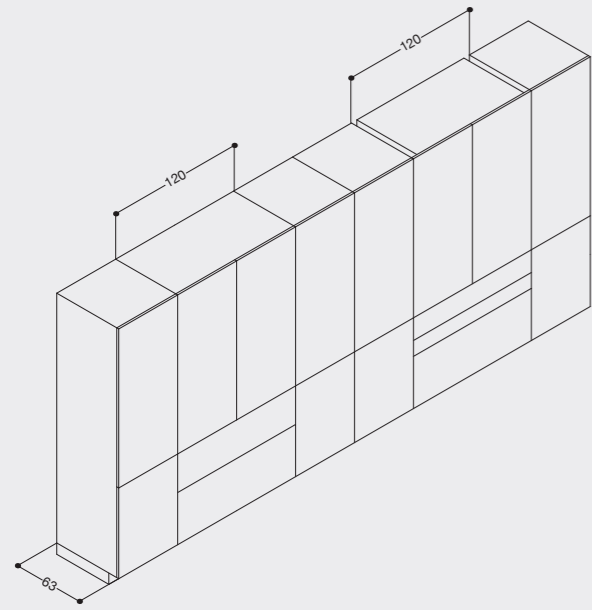

Closed doors_
CONFIGURAZIONE AD ANTE CHIUSE

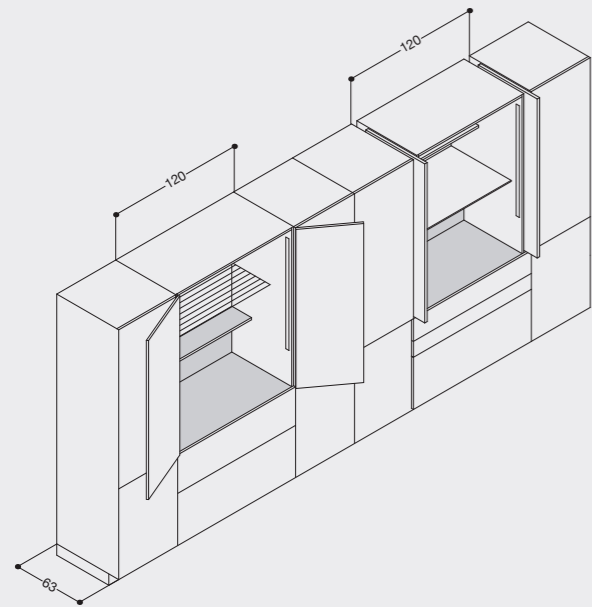

Gourmet half-columns with two different opening systems prepared for small appliances_
SEMICOLONNE GOURMET CON DUE TIPI DI APERTURE PREDISPOSTE PER I PICCOLI ELETTRODOMESTICI

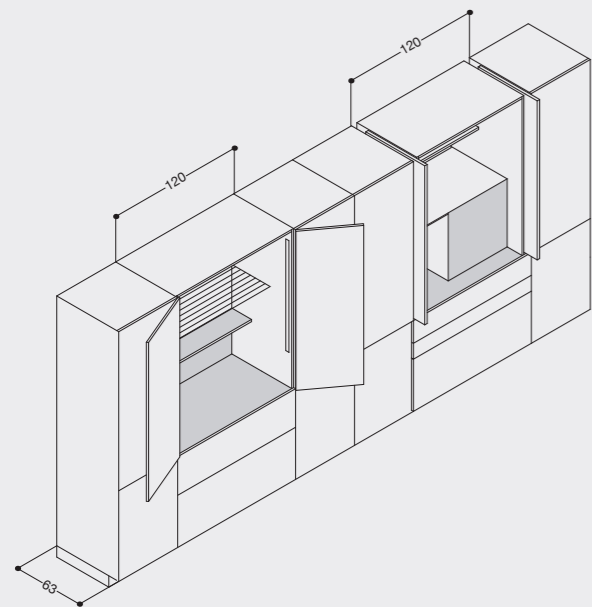

Gourmet half-columns with two different opening system prepared for oven and small appliances_
SEMICOLONNE GOURMET CON DUE TIPI DI APERTURA PREDISPOSTE PER FORNI DA INCASSO E/O PICCOLI ELETTRODOMESTICI.

90 and 120 cm Gourmet Half-Columns and Columns, Depth 63 cm_

SEMICOLONNE E COLONE GOURMET DA 90 E 120 cm, PROF.63 cm

Sono la soluzione ideale per riporre ed utilizzare i piccoli elettrodomestici, per aumentare la superficie operativa, per conservare gli ingredienti e contenere gli utensili e a mantenere facilmente tutto in ordine.

Internamente sono dotate di serie di un piano di lavoro rivestito in acciaio, di prese elettriche, di ripiani interni e di luci LED e possono anche essere personalizzate con gli interni colorati.

Sono presenti in tutte le nostre collezioni ed è possibile scegliere tra il sistema di aperura ad ante a battente o rientranti.

These are the ideal solution to store and use small appliances, to increase working space, to store ingredients and contain utensils, while keeping everything tidy.

On the inside they come with a steel-lined worktop, electrical sockets, internal shelves and LED lights. They can also be personalised with coloured insides.

They are available across all our collections and slide away and opening doors can be chosen for the opening system.

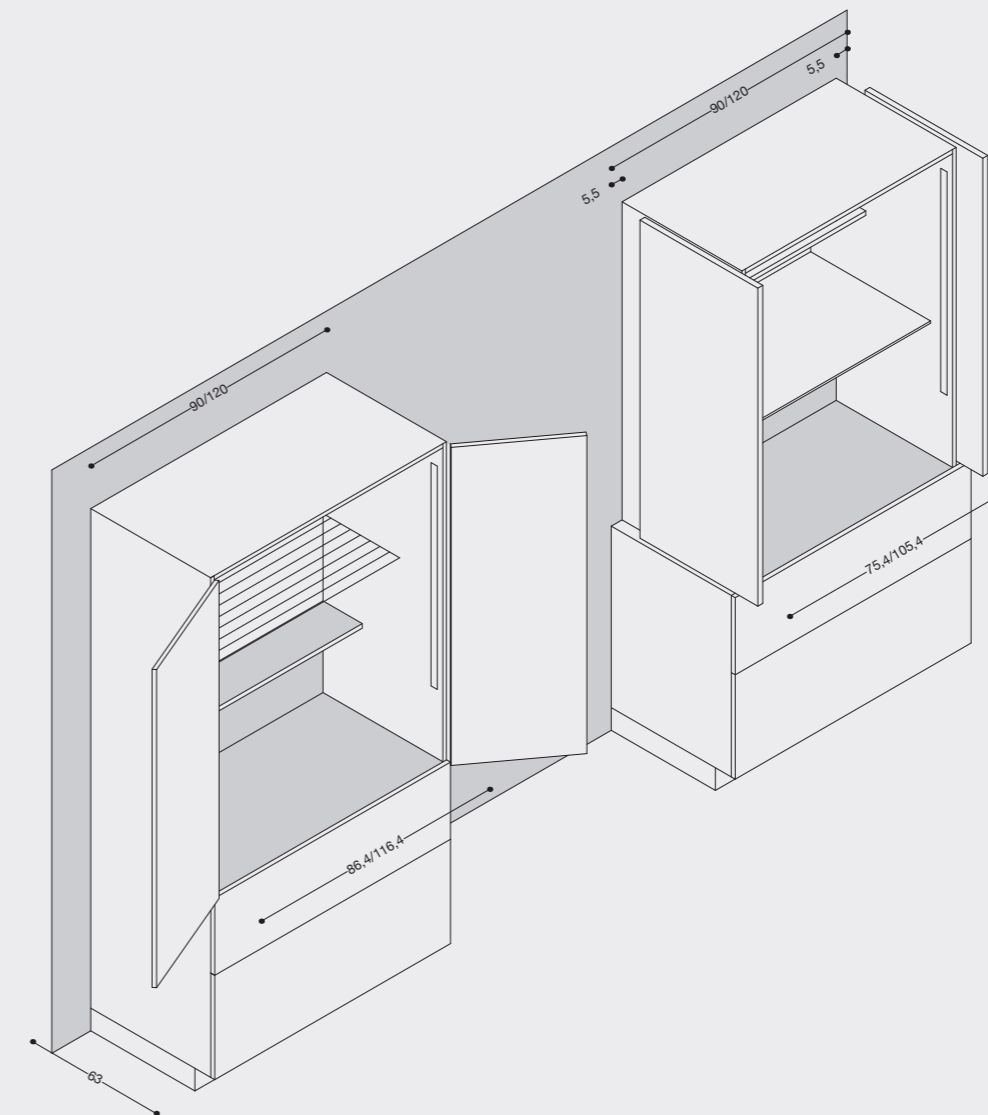

The traditional_

REGULA

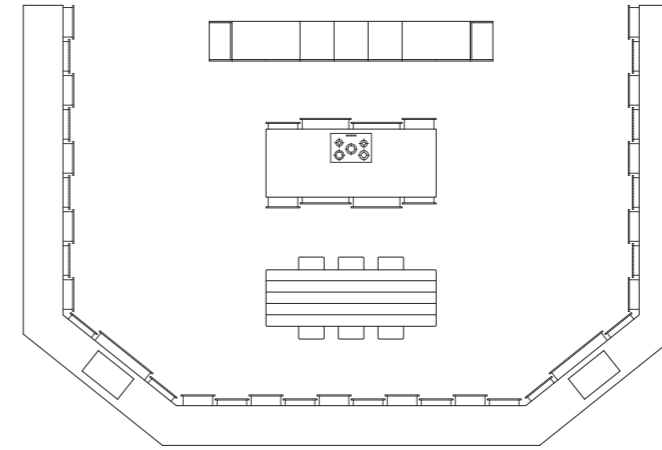

BASI E ISOLA_
BASE UNITS AND ISLAND

●
Laccato artico 7040
Artic lacquered 7040

●
Acciao finitura titanio scuro
Stainless steel dark titanium
finish

COLONNE_
TALL UNITS

●
Laccato artico 7040
Artic lacquered 7040













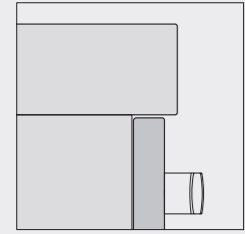

Regula_
REGULA

Wall units_
ELEMENTI A MURO

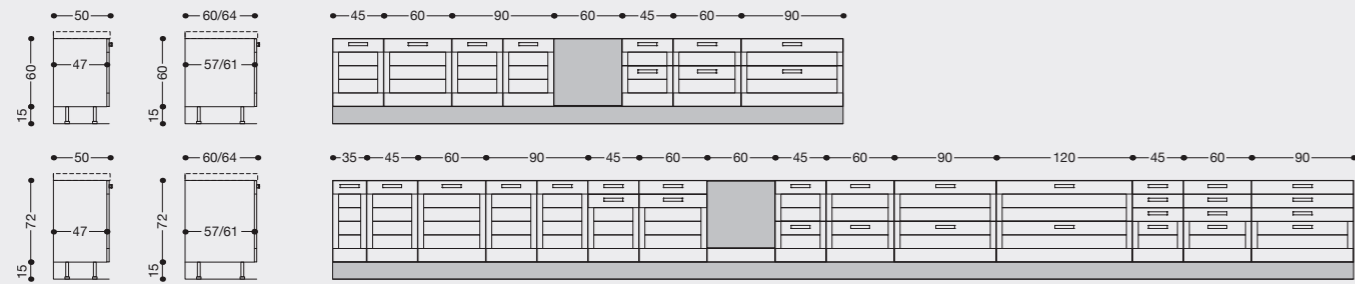

Wall units_
ELEMENTI A MURO

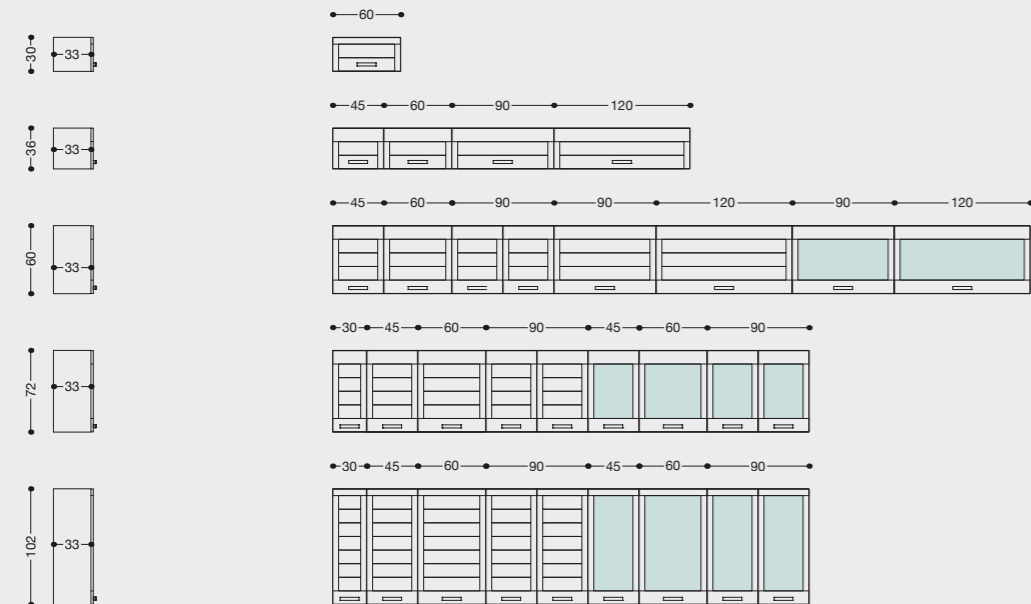

High_
ALTEZZA

46 cm

90,2 cm

High_
ALTEZZA

36 cm

36 cm

60 cm

72 cm

102 cm

Alignements wall units and tall units_
ALLINEAMENTO UNITÀ A MURO E COLONNE



High_
ALTEZZA

143 cm

210 cm

245 cm

245 cm

Island_ ISOLA

L'ampia modularità delle nostre collezioni vi permette di progettare le isole con estrema libertà.

The wide modularity of our collection allows you to design the islands with extreme freedom.

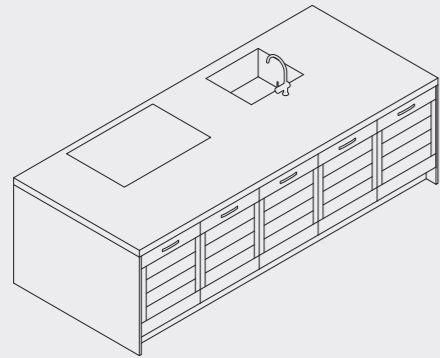

Island with containers on both sides_
ISOLA CON CONTENITORI SU ENTRAMBI I LATI

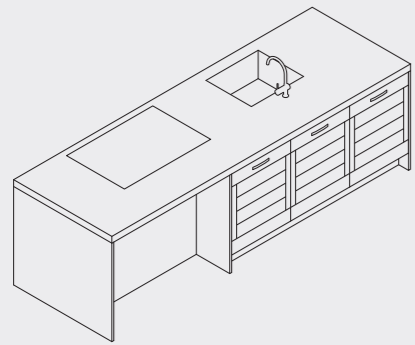

Island with containers and snack area at the back_
ISOLA CON CONTENITORI E AREA SNACK SU RETRO

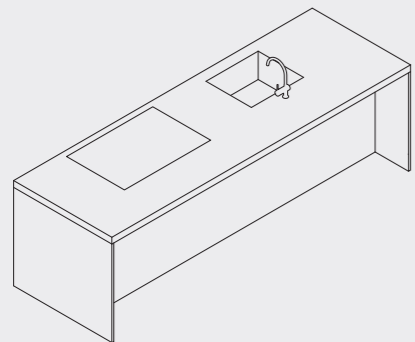

Island with snack area at the back_
ISOLA CON ZONA SNACK SUL RETRO

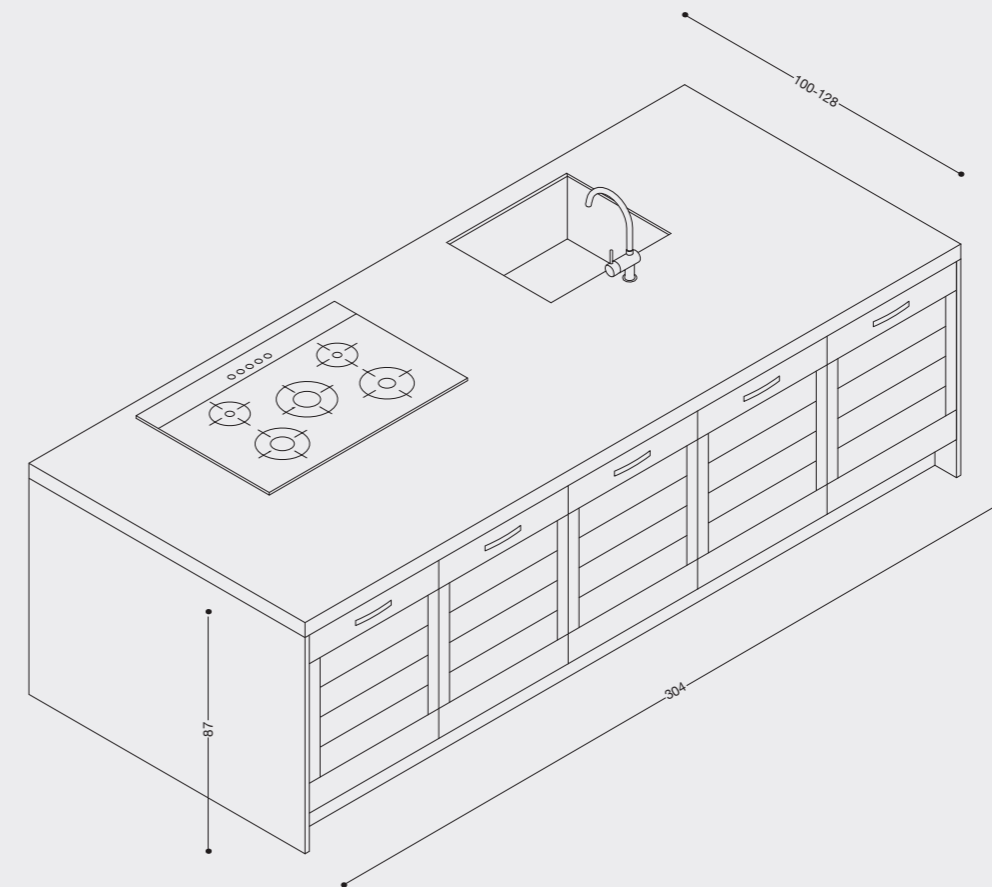



Materials_
MATERIALI

Doors_
ANTE

Melamine finishes matt solid_
DECORATIVO TINTA UNITA OPACO

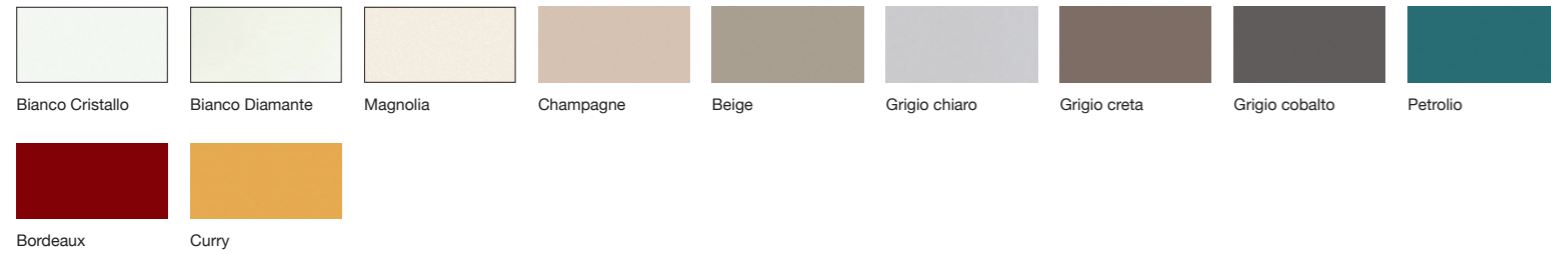

Melamine finishes ash pore_
DECORATIVO TINTA UNITA PORO FRASSINO

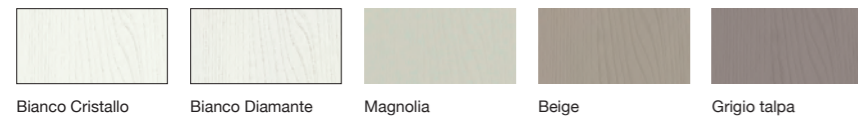

Melamine finishes concrete_
DECORATIVO CEMENTO

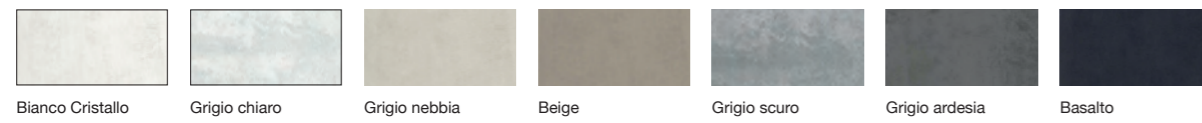

Melamine finishes wood_
DECORATIVO LEGNO

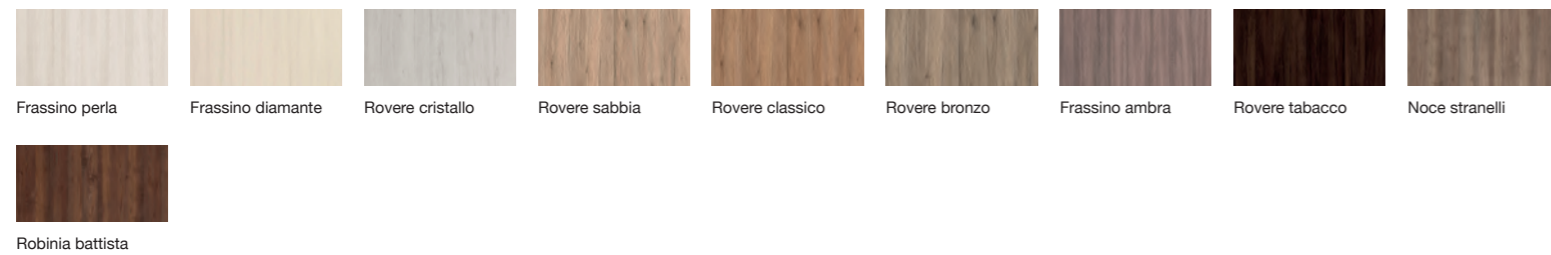

Metallic finishes_
DECORATIVO METALLICO

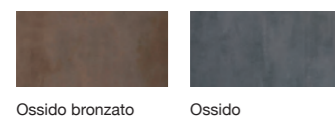

Silk_
SILK

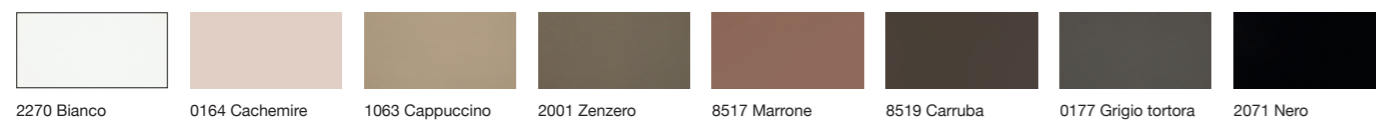

Matt acrylic_
ACRILICO OPACO

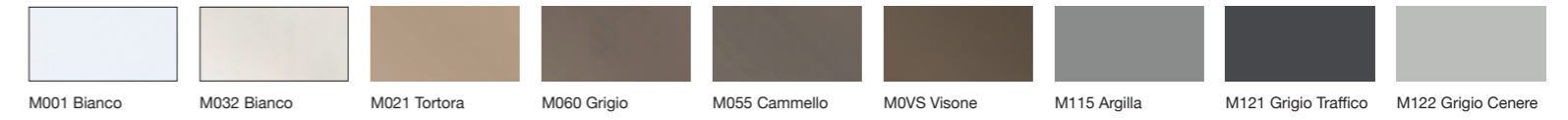

Gloss acrylic_
ACRILICO LUCIDO



Glaks organic glass gloss / frosted_
GLAKS VETRO ORGANICO LUCIDO / SATINATO

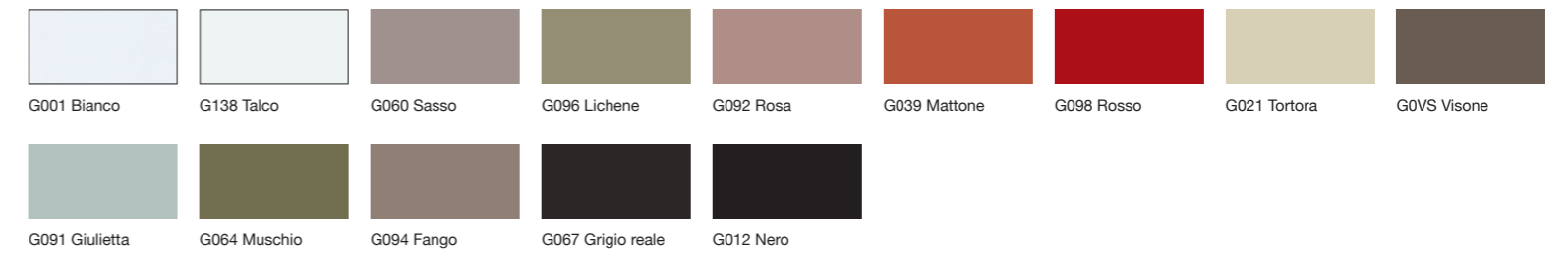

Fenix_
FENIX

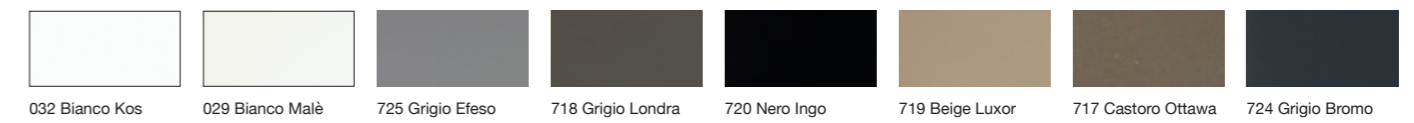

Matt lacquers / Gloss lacquers_
LACCATO OPACO / LACCATO LUCIDO

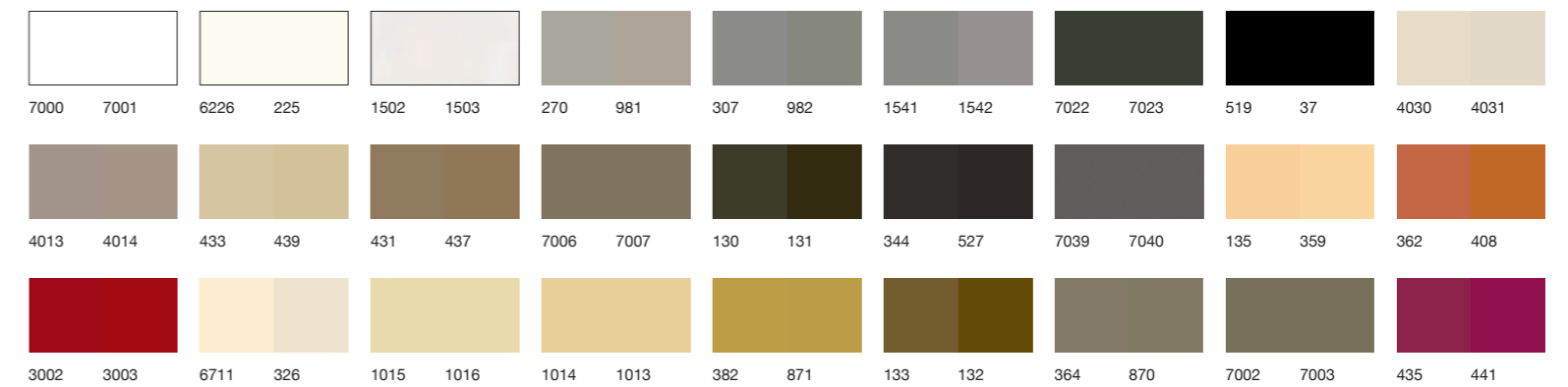

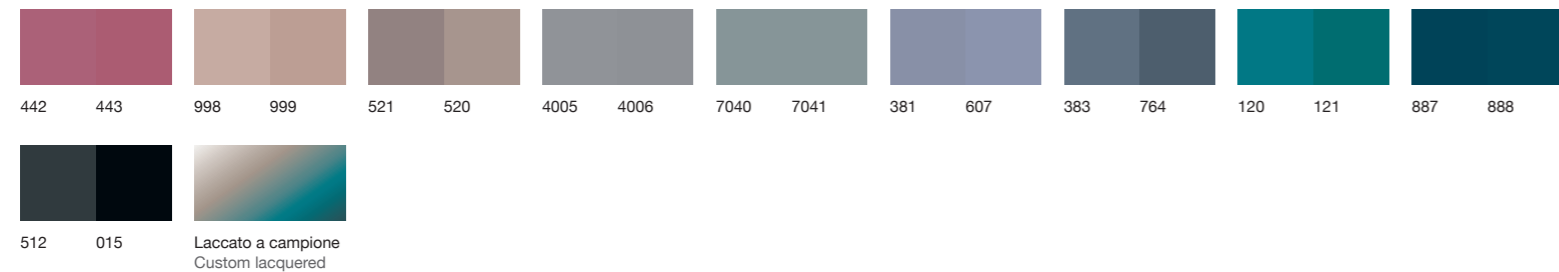

Clay_
ARGILLA



Cement_
CEMENTO



Gres_
GRES

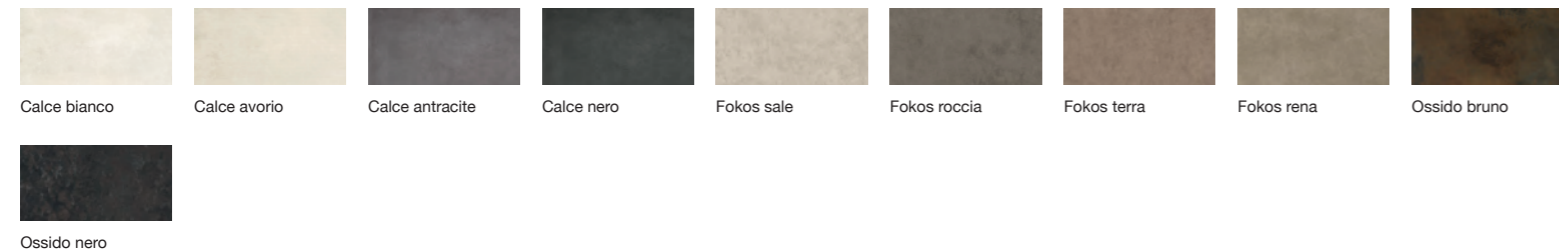

Venered oak, painted_
ROVERE IMPIALLACCIATO TINTO

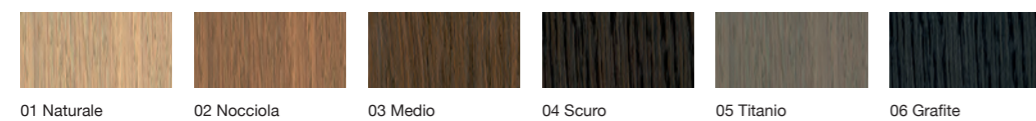

Precius wood type W1_
LEGNI PREGIATI OPACHI W1

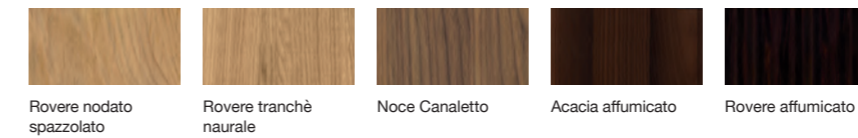

Precius wood type W2_
LEGNI PREGIATI OPACHI W2

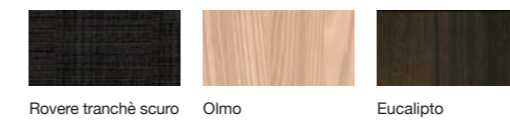

Precius wood type W3_
LEGNI PREGIATI OPACHI W3

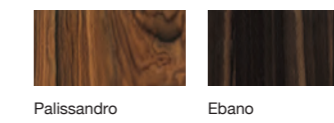

Custome woods_
Legni custom

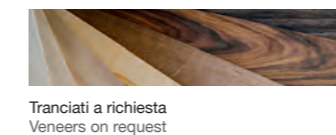

Precius wood waxed glossy laquer*_
LEGNI PREGIATI LACCATI PARAFFINATI*

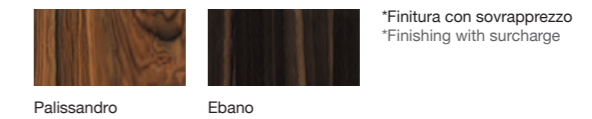

Metallic lacquer_
LACCATO METALLICO

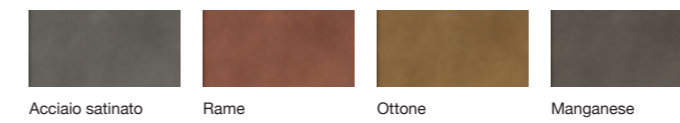

Stainless steel_
ACCIAIO INOX

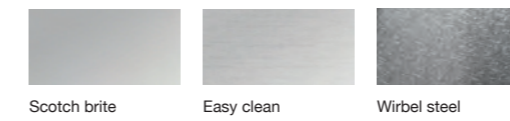

Stainless steel special finishing_
ACCIAIO INOX FINITURE SPECIALI

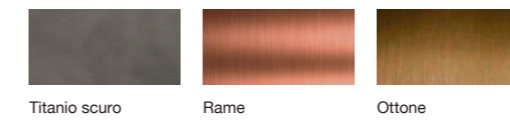

Tops_
PIANI

Laminate_
LAMINATO

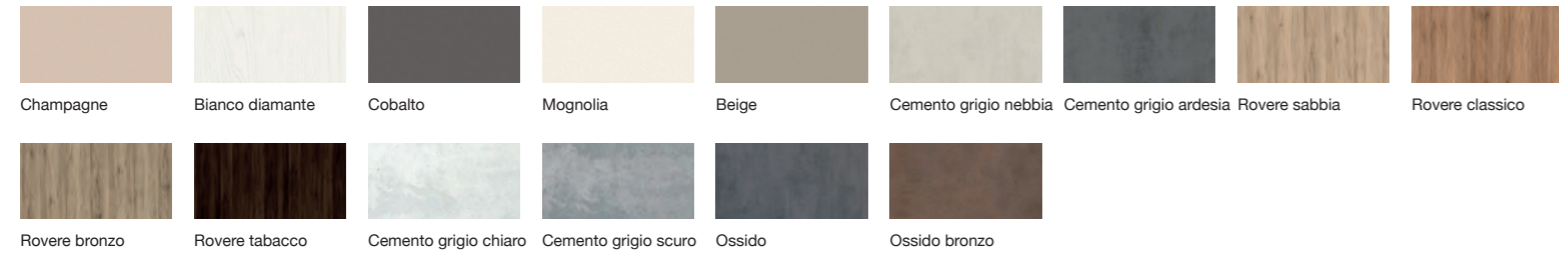

Fenix_
FENIX

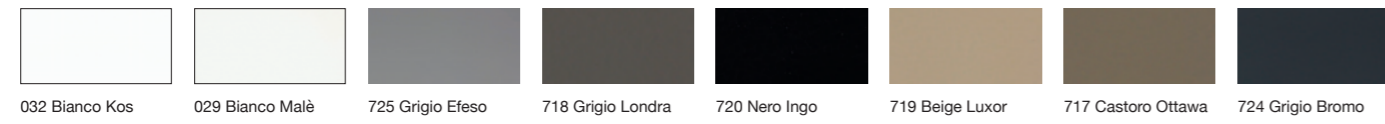

Elmarstone_
ELMARSTONE

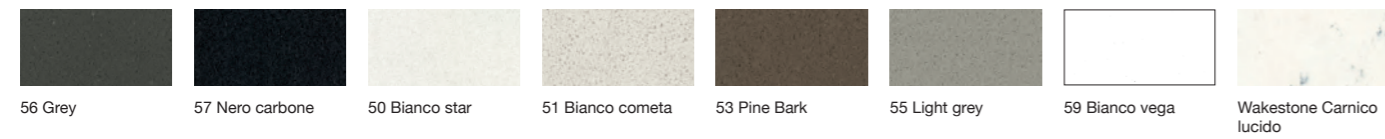

Mattestone_
MATTESTONE

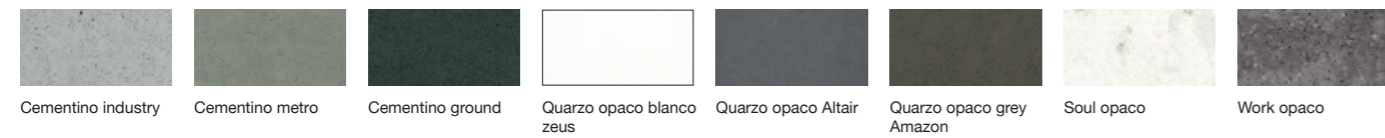

Gres_
GRES

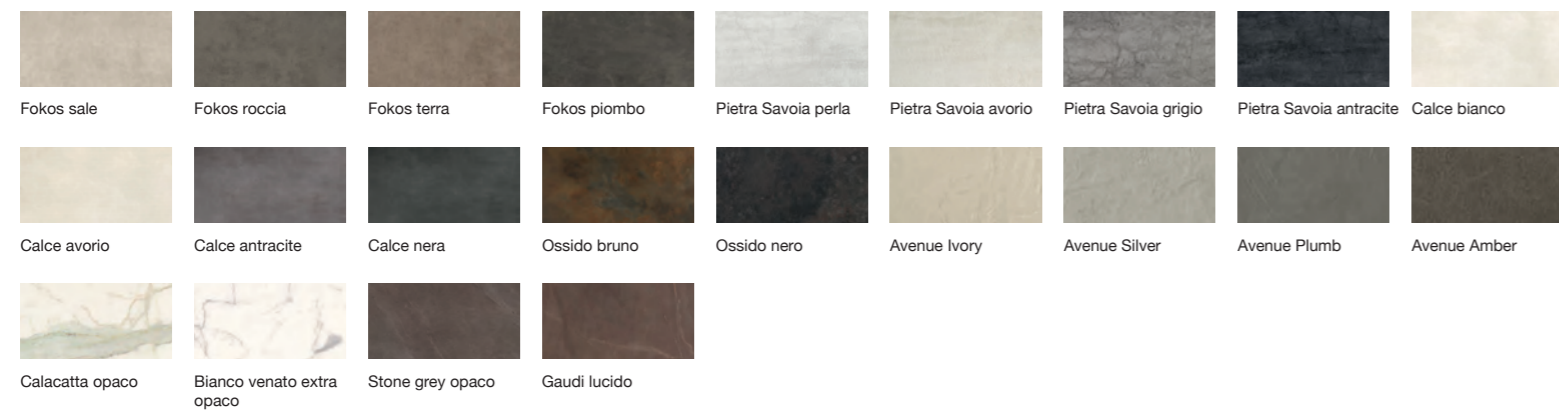

Jaipur_
JAIPUR

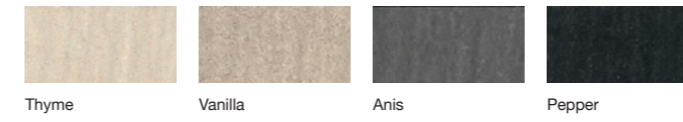

Marble_
MARMO

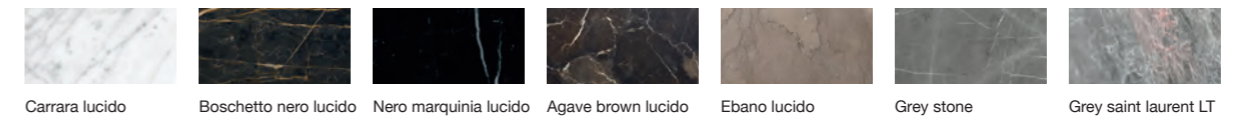

LG-HI-Macs_
LG-HI-MACS



Elmarinox_
ELMARINOX

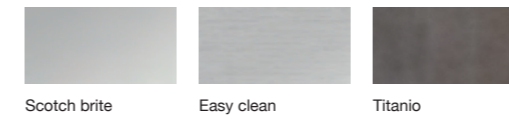

Barazza stainless steel_
INOX BARAZZA



ELMAR srl

Via E. Salgari 18
31056 Biancade (TV) Italy
Tel. +39 0422 849142

www.elmarcucine.com
elmar@elmarcucine.com

AD: C+S Architects
Images: nudesignstudio
Photos: Alessandra Bello, Pietro Savorelli
Print: Grafiche Antiga, marzo 2018

